

TILER[®]

CATALOG

SINCE 1996

2023 — 2024



| MAKE TILING EASY |

TILER[®]

1 ABOUT TILER

2 TILE CUTTING MACHINE

Manual tile cutters 09
Accessories for tile cutters 19

3 LARGE FORMAT SLAB SYSTEM

Cutters for large format slab 21
Working bench for large format slab 25
Handing system for large format slab 27
Trolley for large format slab 29
Accessories for large format slab system 31

4 TILE CARRYING & LAYING TOOLS

Tile vibration machine 33
Vacuum suction cup 35
Aluminum suction cup 35

5 TILE LEVELING TOOLS

Tile spacers 37
Tile leveling system 39

6 GROUTING & CLEANING TOOLS

Grouting tools 44
Cleaning tools 46

7 OTHER TILING TOOLS

Other tiling tools 48

ABOUT TILER



1996

HangZhou John Hardware
Tools Co., LTD. **Established**

1999

First Tile Cutter
Exported to Poland

2008

Interviewed by
National China Central Television
(CCTV)

2010

Became **Global Sales Leader**
in Tile Cutting Machines

2015

A **Top-Level Tile Cutting Machine**
Was Designed in Collaboration with
German Experts

2022

Dedicated to Recruit
TILER Distributors Worldwide



Company Profile

30+ years

Industry Experience

130+

Countries

For Every **5** Tile Cutting Machines Sold Globally

1 was Produced by TILER

40,000+ m²

Workshop

30 days

Delivery Time

Patent

71

Core technology invention patents

8

Granted invention patents

38

Utility model patents

25

Design patents

Certificate





PRODUCT CONCEPT

Precise: TILER's commitment to precision ensures that you achieve flawless results with every performance. We understand the importance of accuracy in your work, so TILER products are meticulously designed and crafted to deliver consistent and precise outcomes. Whether you're a professional in a specialized field or an enthusiast pursuing your passion, TILER products will empower you to achieve the highest level of precision in your endeavors.

Innovative: Stay ahead and upgrade your work with innovative technology. TILER continuously push the boundaries of innovation to bring you cutting-edge tools that enhance your capabilities and unleash your creativity. TILER's commitment to innovation drives us to explore new possibilities, develop groundbreaking solutions, and integrate the latest advancements into TILER products. Embrace the power of innovation and unlock a world of endless possibilities in your work.

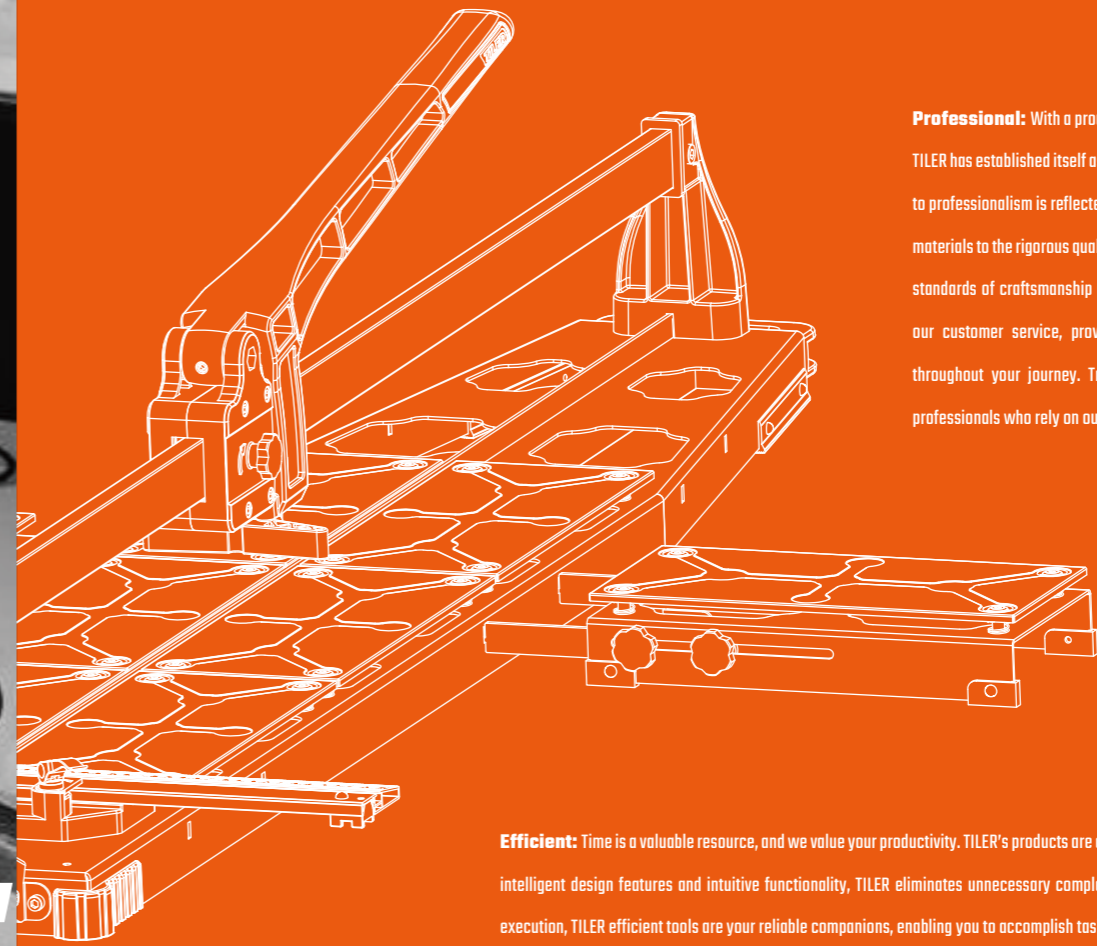

Professional: With a proud heritage of manufacturing high-quality tools for over 28 years, TILER has established itself as a trusted brand in the industry. TILER is unwavering commitment to professionalism is reflected in every aspect of our products. From the selection of premium materials to the rigorous quality control processes, we ensure that each tool meets the highest standards of craftsmanship and durability. TILER's dedication to professionalism extends to our customer service, providing you with a seamless experience and reliable support throughout your journey. Trust in our expertise and experience, and join the countless professionals who rely on our tools to achieve excellence in their work.

Efficient: Time is a valuable resource, and we value your productivity. TILER's products are engineered to help you complete projects quickly and easily. With intelligent design features and intuitive functionality, TILER eliminates unnecessary complexities and streamline your workflow. From project planning to execution, TILER efficient tools are your reliable companions, enabling you to accomplish tasks with optimal efficiency and effectiveness.

ABOUT TILER

"TILER" is a high-end brand dedicated to manufacturing tile cutting and installation tools. As an independent brand created by Hangzhou John Hardware Tools Co., Ltd., its parent company, TILER has been committed to providing global users with high-quality and high-efficiency tiling tools. Since the development of the first tile cutting machine, the company has continuously innovated, accumulated experience, and consistently strived to deliver professional tile cutting and installation tools.

With 30 years of innovative research and development technology and efficient production capabilities, TILER has become a leader in the global tiling tools industry, serving customers in over 130 countries and maintaining the top global sales of tile cutting machines for 10 consecutive years.

TILER is renowned for its craftsmanship spirit. Constantly Pursuing excellence in quality at its core. The brand is dedicated to manufacturing each product with efficiency, precision, professionalism, innovation, and safety as its guiding principles. Through advanced design, high-quality products, and customized services, TILER provides every user with an enjoyable tile installation experience. Whether you are a professional or a DIY installer, you can find satisfactory solutions in the products and services offered by TILER.

MISSION

We are committed to providing installers with high-quality and high-efficiency tools for cutting and laying tiles, while creating a "resource-saving and environmentally friendly" living environment for humanity.

VISION

To become a respected global century-old enterprise in the tiling tools industry.

TILE CUTTING MACHINE

TILER Tile Cutters are available in various models to cater to different needs. They feature metal alloy materials as well as aluminum alloy materials, and come with both single-rail sliding system and double-rail sliding system. We offer machines suitable for standard tile sizes such as 24 inches and 32 inches, as well as machines designed for large-sized tiles like 72 inches or even up to 144 inches. We have options suitable for DIY installers as well as machines specifically designed for professional installers.

TILER not only provides tile cutters but also offers comprehensive technical support and after-sales service. We are committed to establishing long-term partnerships with our customers, working together to drive the development of the tile industry and providing high-quality cutting solutions to users.



Y3 SPEEDY ROCKET TILE CUTTER

Y3-1050 / Y3-1300 / Y3-1550



1050-1550 mm	CUTTING ANGLE 0-60°	18 mm (max)	1200 KG
	22x6x6 mm YG-6X	Ti COATED	



Robust wide base, guide, and breaking system.



Extended labor-saving handle.



Spring pads with shock absorber for better tile breaking.



80cm aluminum adjustable gauge for fast and accurate measurement.



Heavy-duty extension feet with spring pads for supporting large size tile.

MANUAL TILE CUTTERS

MODEL	SIZE			
Y3-1050	42"	1050mm	740mm	18mm
Y3-1300	52"	1300mm	920mm	18mm
Y3-1550	62"	1550mm	1095mm	18mm
ø22*ø6*6mm	1PC/CTN	27KG	136*35.5*28.5CM	
ø22*ø6*6mm	1PC/CTN	32KG	161*35.5*28.5CM	
ø22*ø6*6mm	1PC/CTN	35.5KG	186*35.5*28.5CM	

T3 PREM. RAPTOR TILE CUTTER

T3-1200 / T3-1600 / T3-1800



1200-1800 mm	CUTTING ANGLE 45°/90°	16 mm (max)	1200 KG
	22x6x6 mm YG-6X	Ti COATED	LASER



MODEL	SIZE			
T3-1200	48"	1200mm	850mm	16mm
T3-1600	64"	1600mm	1130mm	16mm
T3-1800	72"	1800mm	1270mm	16mm
∅22*∅6*6mm	1PC/CTN	18KG	153*17.5*26CM	
∅22*∅6*6mm	1PC/CTN	28KG	193*17.5*26CM	
∅22*∅6*6mm	1PC/CTN	30KG	213*17.5*26CM	



Patented lockable break bar for visible cutting performance.



Aluminum gauge, beautiful and precise.



Equipped with infrared laser for more precise cutting.



Extended labor-saving handle, ergonomic and heavy-duty construction.



Fully enclosed and self-adjusting sliding system.

T2 RAPTOR TILE CUTTER

T2-800 / T2-1000 / T2-1200



800-1200 mm	CUTTING ANGLE 45°/90°	16 mm (max)	1000 KG
	22x6x6 mm YG-6X	Ti COATED	LASER



Fully enclosed slider, dust-free and no adjustment needed.



TILER premium cutting wheel, long-lasting life.



Patented lockable break bar for visible cutting performance.



Hidden extension feet for large tiles and easy carrying.



Equipped with infrared laser for more precise cutting.

MODEL	SIZE			
T2-800	32"	800mm	565mm	16mm
T2-1000	40"	1000mm	705mm	16mm
T2-1200	48"	1200mm	850mm	16mm
ø22*ø6*6mm	1PC/CTN	12.5KG	113*17.5*26CM	
ø22*ø6*6mm	1PC/CTN	15KG	133*17.5*26CM	
ø22*ø6*6mm	1PC/CTN	18KG	155*17.5*26CM	

Y1 LIGHTNING TILE CUTTER

Y1-900 / Y1-1200 / Y1-1550



- Handle with soft grip for better ergonomics and comfort.
- Aluminum base for robustness, light and easy to transport.
- Comes with 2 extra aluminum extension feet for large tiles.
- Reinforced guide, greater bending resistance and increased precision.
- 80cm aluminum adjustable gauge for fast and accurate measurement.
- Guide system highly resistant to impacts resulting in longer product life.
- Patented lockable breaker with plastic protector, ensuring better visibility of scoring and cutting zone.

MODEL	SIZE			
Y1-900	36"	900mm	635mm	16mm
Y1-1200	48"	1200mm	850mm	16mm
Y1-1550	62"	1550mm	1095mm	16mm
ø22*ø6*6mm	2PC/CTN	20KG	116*25*26CM	
ø22*ø6*6mm	1PC/CTN	14KG	146*25*26CM	
ø22*ø6*6mm	1PC/CTN	18KG	181*25*26CM	

Patented

Life Warranty

900-1550 mm

CUTTING ANGLE 0-60°

16 mm (max)

1000 KG

22x6x6 mm YG-6X

Ti COATED

Al

T1 UNIVERSAL TILE CUTTER

T1-600 / T1-800



- Magnetic breaker provides direct view of scoring line.
- Fast operating system with magnet, for one-hand use.
- Handle with soft grip for better ergonomics and comfort.
- Wide base surface for higher stability and cutting quality.
- Heavy-duty metal extension feet for excellent tile placement.
- Reinforced supporters for heavy-duty work, and high durability.
- The adjustable aluminum gauge provides greater precision in angle cuts.

MODEL	SIZE			
T1-600	24"	600mm	425mm	14mm
T1-800	32"	800mm	565mm	14mm
ø22*ø6*6mm	2PC/CTN	15KG	86*20*49CM	
ø22*ø6*6mm	2PC/CTN	18KG	106*20*49CM	

Patented

Life Warranty

600-800 mm

CUTTING ANGLE 0-60°



14 mm (max)

800 KG

22x6x6 mm YG-6X

Ti COATED



NAME	MODEL	INCH							
			mm	mm	mm	kg	mm	ADJUSTABLE FROM 0° - 60°	FIXED 0°/45°
	Y3-1050	42"	1050	742	18	1200	ø22*ø6*6	✓	
	Y3-1300	52"	1300	920				✓	
	Y3-1550	62"	1550	1095				✓	
	T2-800	32"	800	565	16	1000	ø22*ø6*6	✓	
	T2-1000	40"	1000	705				✓	
	T2-1200	48"	1200	850				✓	
	T3-1200	48"	1200	850	16	1000	ø22*ø6*6	✓	
	T3-1600	64"	1600	1130				✓	
	T3-1800	72"	1800	1270				✓	
	Y1-900	36"	900	635	16	1000	ø22*ø6*6	✓	
	Y1-1200	48"	1200	850				✓	
	Y1-1550	62"	1550	1095				✓	
	T1-600	24"	600	425	14	800	ø22*ø6*6	✓	
	T1-800	32"	800	565				✓	



8117-22B

CUTTING WHEEL

- Size : Ø22xØ6x6mm.
- High-quality replaceable accessory for TILER manual tile cutters.
- Maximum cutting length of 2000m.
- Crafted from premium tungsten carbide material.

MODEL		
8117-22B	100PCS	300PCS



8117-22BT

TITANIZE CUTTING WHEEL

- Size : Ø22xØ6x6mm.
- High-quality replaceable accessory for TILER manual tile cutters.
- Maximum cutting length of 2000m.
- Crafted from premium tungsten carbide material and features a special titanize coating.

MODEL		
8117-22BT	100PCS	300PCS

SCORING WHEEL	ART	NAME				APPLICABLE
	8117-22B	CUTTING WHEEL	22mm	6mm	6mm	Y1,Y3,T1,T2,T3
	8117-22BT	TITANIZE CUTTING WHEEL	22mm	6mm	6mm	Y1,Y3,T1,T2,T3

LARGE FORMAT SLAB SYSTEM

Large format slabs are expensive, and their large size increases the difficulty of handling them, as well as the risk of damage. To address these issues, TILER has developed and designed a complete range of products specifically tailored for large format slabs. The TILER Large Format Slab System is designed to ensure the safe and efficient handling of slabs throughout the installation process. This includes workbenches that can accommodate large format slabs, as well as manual and electric cutting machines specifically designed for cutting large format slabs, catering to the cutting needs of installers working with various thicknesses of tiles. In addition, there are equipments available for efficient and effortless transportation of large format slab tiles.

DB-3

PREM. LARGE FORMAT SLAB CUTTER

CUTTERS FOR LARGE FORMAT SLAB



- Cutting thickness ranges from 4mm to 12mm.
- Designed specifically for cutting large format slabs.
- Convenient TILER carrying bag for storage and easy transportation.
- Extended ergonomic handle for comfortable and effortless operation.
- Crafted from premium aluminum alloy, ensures lightweight construction and convenience.
- High-quality bearing wheels enable cutting lengths up to 2000 meters and facilitate easy replacement.
- Built-in suction cups on the guide rails eliminate the hassle of attaching separate suction devices, providing secure adhesion to the material being cut.

GUIDE RAILS CAN BE FLEXIBLY COMBINED TO ACCOMMODATE DIFFERENT DIMENSIONS.

YOU HAVE THE OPTION TO CHOOSE FROM: 1800MM, 2800MM AND 3800MM.

3800+ mm	FAST LIGHT	12 mm (max)
	22x6x6 mm YG-6X	Ti COATED
		1000 KG

MODEL			
DB-3	1SET	8KG	150*20*30CM

DE-125

ELECTRIC & MANUAL CUTTER 2 IN 1 KIT



- Includes 125mm & 115mm Diamond disc.
- The manual cutting system can cut up to 12mm.
- The electric cutting system can cut up to 25mm.
- Double dust reduction/control system. Dry and wet cutting.
- Comes with a TILER carry bag for easy storage and handling.
- Switch with safety lock. Prevents unintentional start-up. Electrical cable with PRCD.
- The cutting head is height-adjustable and hinged, allowing for angles ranging from 0° to 48°.
- Comprising 3 assembled extruded aluminum guides, this system enables flawless scoring in large format tiles up to 360cm, resulting in precise and smooth cuts.

MODEL			
DE-125	1SET	15.6KG	136*110*12.8CM(Accessories) 35.5*30*25.8CM(Host Engine)

3600+ mm	BEVEL CHAMFER	 [220V/110V]	 1.4kW
 125/115 mm		25 mm (max)	13800 RPM



DB-TB-3/3600

LARGE FORMAT SLAB WORKING BENCH 3600MM

WORKING BENCH FOR LARGE FORMAT SLAB

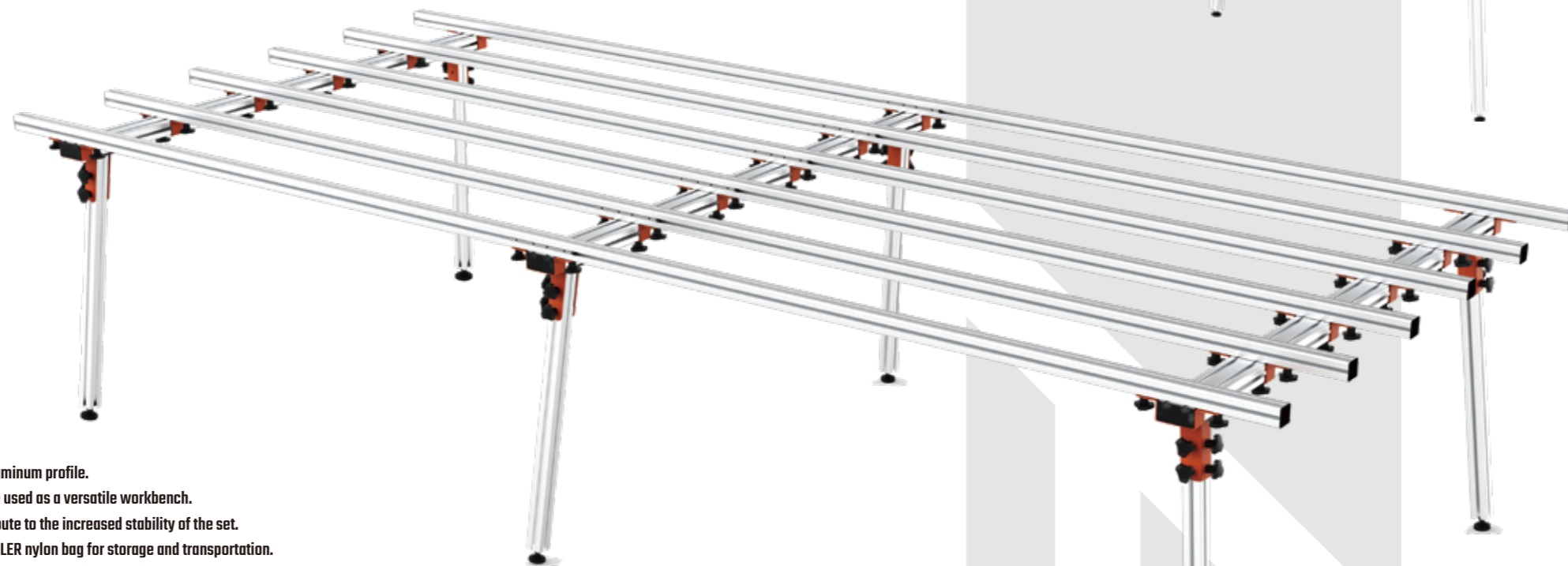

- Rigidity high-quality aluminum profile.
- Multi-functional, can be used as a versatile workbench.
- The leveling feet contribute to the increased stability of the set.
- Comes with a durable TILER nylon bag for storage and transportation.
- Customization options are available for the table surface's anti-slip feature.
- Fast and easy assembly and disassembly with a convenient fixed connection system.
- The extra-reinforced aluminum bars give the Slab working bench a lightweight, high rigidity, and great stability.
- The separation of its 12 aluminum bars allows the user to make perforations and cuts without fear of damaging the table itself.

MODEL			
DB-TB-3/3600	1SET	47.7KG	183*22*27CM

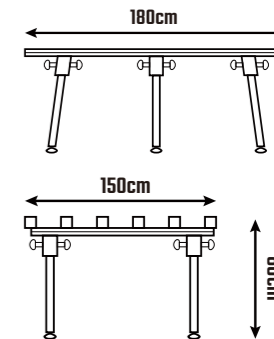
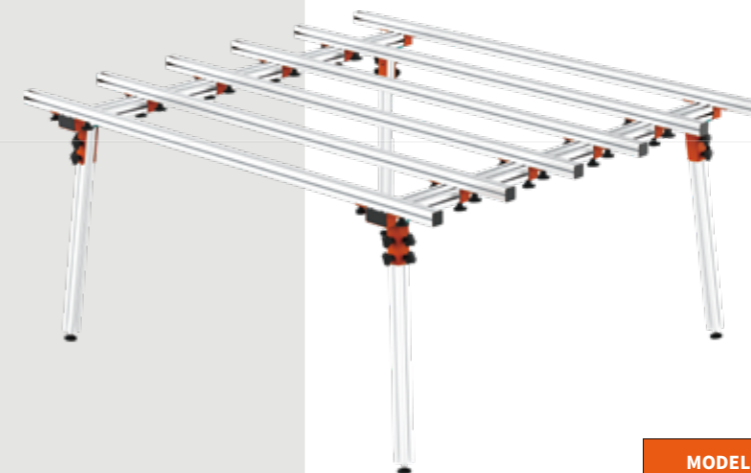

DB-TB-3/1800

MODEL			
DB-TB-3/1800	1SET	38KG	183*26.5*20.5CM

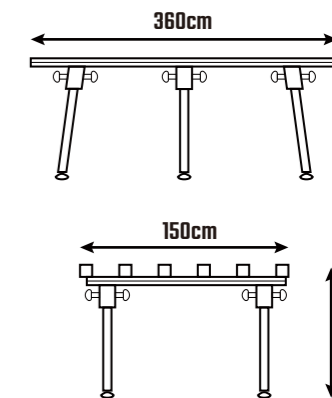

DB-CY-2



LARGE FORMAT SLAB HANDING SYSTEM



- Reinforced aluminum profile. Greater structural strength.
- The crossbars can be easily released for transporting long narrow slabs.
- The set consists of two retractable and adjustable extruded aluminum guides, ranging from 160 to 360 cm.
- The system is equipped with 6 heavy-duty vacuum suction cups that securely fix the system in place.
- These suction cups are easily positionable and allow for adjustable fixing points, ensuring the safe handling of large format sheets.



GREAT FOR LONG NARROW SLABS

100% SAFE	 MAX 150KG
INCLUDES 6x ø200MM	 CARRY BAG
	 360°*160CM

MODEL			
DB-CY-2	1SET	29KG	193*25.5*22.5CM

DB-CY-3



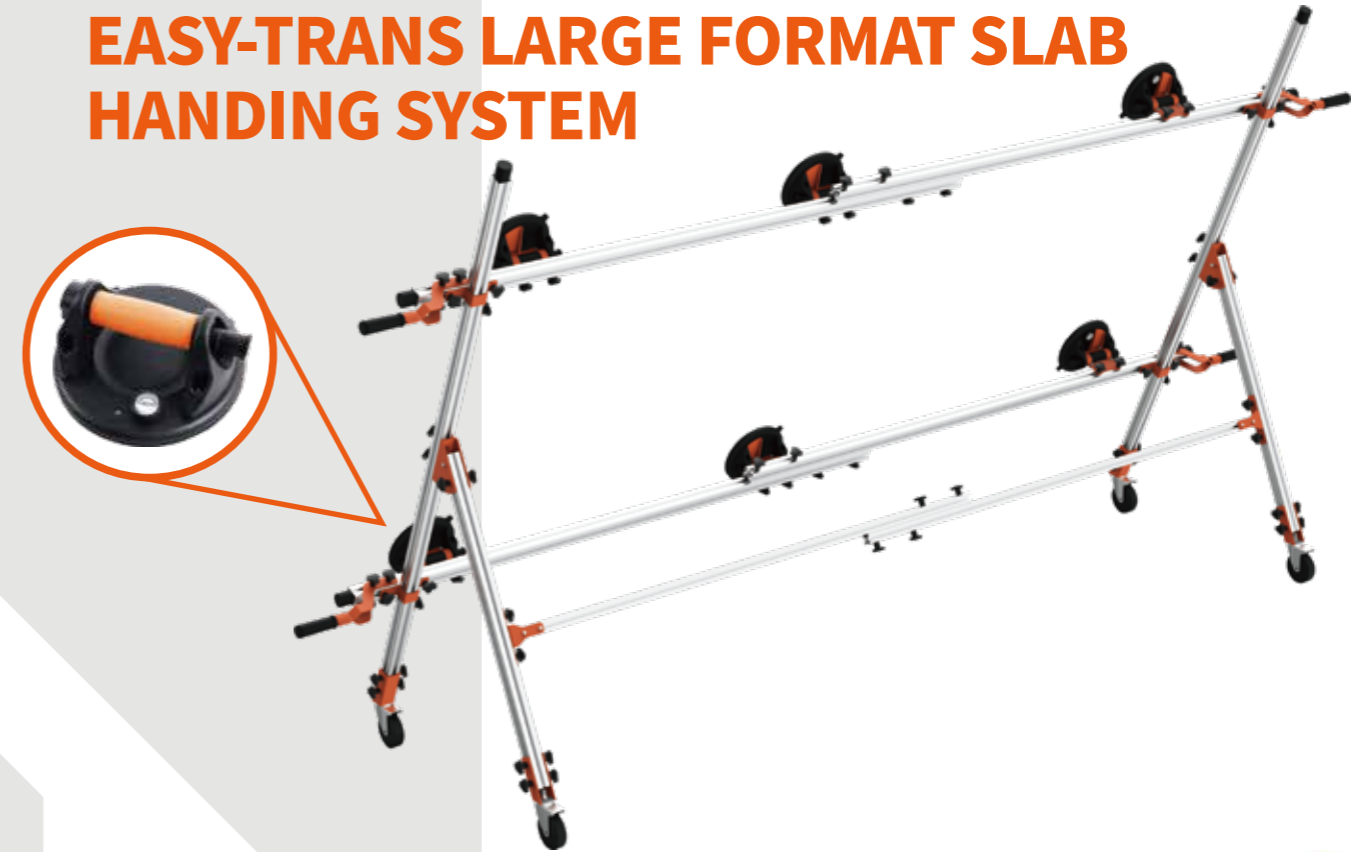

EASY-TRANS LARGE FORMAT SLAB HANDING SYSTEM



- Reinforced aluminum profile. Greater structural strength.
- Comes with 2 detachable and foldable support legs allow the system to stand upright.
- Consists of two retractable and adjustable extruded aluminum guides, ranging from 160 to 360 cm.
- The system is equipped with 6 heavy-duty vacuum suction cups that securely fix the system in place.
- These suction cups are easily positionable and allow for adjustable fixing points, ensuring the safe handling of large format sheets.



GREAT FOR LONG NARROW SLABS

100% SAFE	 MAX 150KG	 CARRY BAG
INCLUDES 6x ø200MM	 360° SPIN AND BRAKE	 360°*160CM
		 STAND UPRIGHT

MODEL			
DB-CY-3	1SET	42.5KG	193*27.5*30CM

DB-TU-2

LARGE FORMAT SLAB TROLLEY

TROLLEY FOR LARGE FORMAT SLAB



- Ultra light and compact.
- Especially suitable for thicker/heavier slabs.
- Equipped with four 360° swivel wheels and braking and locking system.
- Easy and quick to assemble and disassemble. Easy fix connection system.
- Designed with a collapsible base and a durable carrying bag for easy storage and portability.
- Extendable support arm for greater ergonomics when loading and unloading pieces on the workbench.

MODEL			
DB-TU-2	1SET	22.8KG	144*26*20CM

150KG	CARRY BAG	HEAVY DUTY
360° SPIN AND BRAKE	360°*160CM	

	NAME	MODEL	WORKING RANGE	SLAB INFORMATION REFERENCE
	SLAB CUTTER	DB-3	3200MM+	3000X1000X3MM 3000X1000X7MM 1600X3200X5.8MM 1600X3200X8MM
	SLAB CUTTER	DE-125	3800MM+	1600X3200X12MM 1600X2600X5.8MM 1200X2400X5.8MM 1200X2400X9MM
	WORKING BENCH	DB-TB-3	3600MM	1200X1600X12MM 1200X2400X12MM 1200X2700X5.8MM 1500X3000X3MM 1500X3000X6MM
	HANDING SYSTEM	DB-CY-2	3600MM	
	HANDING SYSTEM	DB-CY-3	3600MM	
	TROLLEY	DB-CY-3	3600MM	

8117-22B
CUTTING WHEEL



- Size : Ø22xØ6x6mm.
- High-quality replaceable accessory for TILER manual tile cutters.
- Maximum cutting length of 2000m.
- Crafted from premium tungsten carbide material.

MODEL		
8117-22B	100PCS	300PCS



A91101
DIAMOND DISC 125

- Professional level.
- Size : Ø125xØ22.23x1mm.
- For both wet and dry cutting.
- Made with premium diamond particles.
- Compatible with most electric tile cutters.
- For stone, marble, granite, porcelain and ceramics.

MODEL		
A91101	20PCS	200PCS

8117-22BT
TITANIZE CUTTING WHEEL



- Size : Ø22xØ6x6mm.
- High-quality replaceable accessory for TILER manual tile cutters.
- Maximum cutting length of 2000m.
- Crafted from premium tungsten carbide material and features a special titanize coating.

MODEL		
8117-22BT	100PCS	300PCS



A91104
DIAMOND DISC 115

- Professional level.
- Size : Ø115xØ22.23x1mm.
- For both wet and dry cutting.
- Made with premium diamond particles.
- Compatible with most electric tile cutters.
- For stone, marble, granite, porcelain and ceramics.

MODEL		
A91104	20PCS	200PCS

SCORING WHEEL	ART	NAME				APPLICABLE
	8117-22B	CUTTING WHEEL	22mm	6mm	6mm	DB-3,DE-125
	8117-22BT	TITANIZE CUTTING WHEEL	22mm	6mm	6mm	DB-3,DE-125
	A91101	DIAMOND DISC 125	125mm	22.23mm	1.2mm	DE-125
	A91104	DIAMOND DISC 115	115mm	22.23mm	1.2mm	DE-125

TILE CARRYING & LAYING TOOLS

TILER Tile Carrying & Laying Tools are meticulously designed to optimize workflow, increase productivity, and elevate the overall tiling experience. Our commitment to quality and innovation empowers professionals to achieve exceptional results, while reducing the time and effort required for tile installation.

ART. A71203

TILE VIBRATION MACHINE 20V



- Vibrator Cup Diameter : 160CM
- Battery Capacity : 2000mA
- Battery Voltage : 20V
- Charging Current : 1.5 A
- Battery Charging Time : 2h
- Vibration Frequency : 0-10000r/min
- Vertical Suction : 50KG

- TILER tile vibration machine is a specialized tool used for leveling and setting tiles during installation.
- The machine uses vibrations to distribute the tile adhesive evenly and remove any air pockets or voids between the tile and substrate, resulting in a flat and level surface.

MODEL		
A71203	1PCS	6PCS



ART. A71201

Tile Vibration Machine 20V

- Vibrator Cup Diameter : 130CM
- Battery Capacity : 2000mA
- Battery Voltage : 20V
- Charging Current : 1.5 A
- Battery Charging Time : 2h
- Vibration Frequency : 0-10000r/min
- Vertical Suction : 50KG
- Fast Speed Regulation, Powerful Vibration.
- Extended Battery Life, One-Button Start.
- Fast Tile Laying.

MODEL		
A71201	1PCS	6PCS



ART. A71204

Tile Vibration Machine 20V

- Vibrator Cup Diameter : 190CM
- Battery Capacity : 2000mA
- Battery Voltage : 20V
- Charging Current : 1.5 A
- Battery Charging Time : 2h
- Vibration Frequency : 0-16000r/min
- Vertical Suction : 50KG
- Adjustable vibration intensity with 9 levels.
- Extended Battery Life, One-Button Start.
- Fast Tile Laying.

MODEL		
A71204	1PCS	6PCS





ART. A62201
Electric Vacuum Suction Cup 8"

- One-key start.
- Automatic inflation.
- Durable nitrile rubber.
- Diameter : 200mm/8".
- Load capacity : 150kg.
- With pressure gauge for safe indication.
- Suitable for smooth and rough tiles.

MODEL	📦	📦
A62201	1PCS	6PCS



ART. A62103
Vacuum Suction Cup 8"

- Durable nitrile rubber.
- Diameter : 200mm/8".
- Load capacity : 130kg.
- With pressure gauge for safe indication.
- Suitable for smooth and rough tiles.

MODEL	📦	📦
A62103	1PCS	6PCS



ART. A62104
Heavy Duty Vacuum Suction Cup 8"

- Durable nitrile rubber.
- Diameter : 200mm/8".
- Load capacity : 150kg.
- With pressure gauge for safe indication.
- Suitable for smooth and rough tiles.

MODEL	📦	📦
A62104	1PCS	6PCS



ART. A62105
Pro. Vacuum Suction Cup 8"

- Durable nitrile rubber.
- Diameter : 200mm/8".
- Load capacity : 150kg.
- With pressure gauge for safe indication.
- Suitable for smooth and rough tiles.

MODEL	📦	📦
A62105	1PCS	6PCS



ART. A61201
Single Aluminum Suction Cup

- Material : Nitrile Rubber
- Diameter : 123MM
- Load capacity : 50KG

MODEL	📦	📦
A61201	1PCS	10PCS



ART. A61202
Double Aluminum Suction Cup

- Material : Nitrile Rubber
- Diameter : 123MM
- Load capacity : 80KG

MODEL	📦	📦
A61202	1PCS	10PCS



ART. A61203
Triple Aluminum Suction Cup

- Material : Nitrile Rubber
- Diameter : 123MM
- Load capacity : 100KG

MODEL	📦	📦
A61203	1PCS	10PCS



ART. A63101
Adjustable Suction Cup

- Material : Nitrile Rubber
- Diameter : 123MM
- Load capacity : 100KG

MODEL	📦	📦
A63101	1PCS	12PCS

TILE LEVELING TOOLS

TILER Tile Leveling Tools, a comprehensive range of innovative solutions designed to achieve flawless tile installations with perfect leveling and precise grout spacing. These tools are essential for ensuring professional results, eliminating lippage, and creating a seamless finish in any tiling project.

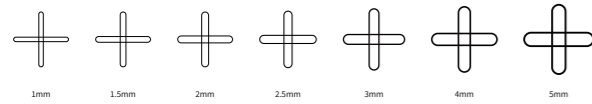

ART. 8119-3 X-type Tile Spacers



X-type Tile Spacers 1.0mm	200 PCS	100 BAGS	38*20*18CM
X-type Tile Spacers 1.5mm	200 PCS	100 BAGS	38*20*18CM
X-type Tile Spacers 2.0mm	200 PCS	100 BAGS	38*20*20CM
X-type Tile Spacers 2.5mm	200 PCS	100 BAGS	38*20*20CM
X-type Tile Spacers 3.0mm	200 PCS	100 BAGS	38*20*22CM
X-type Tile Spacers 4.0mm	100 PCS	100 BAGS	48*22*22CM
X-type Tile Spacers 5.0mm	100 PCS	100 BAGS	48*22*24CM

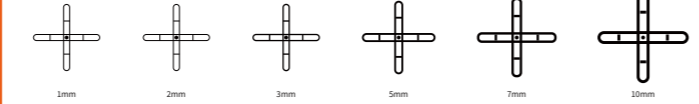

ART. 8119-8 Hollow Tile Spacers



Hollow Tile Spacers 1mm	200 PCS	100 BAGS	38*20*18CM
Hollow Tile Spacers 2mm	200 PCS	100 BAGS	38*20*18CM
Hollow Tile Spacers 3mm	200 PCS	100 BAGS	38*20*20CM
Hollow Tile Spacers 5mm	100 PCS	100 BAGS	45*40*35CM
Hollow Tile Spacers 7mm	100 PCS	100 BAGS	45*40*40CM
Hollow Tile Spacers 10mm	100 PCS	100 BAGS	45*40*50CM

ART. 8119-2 T-type Tile Spacers

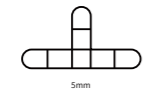

T-type Tile Spacers 5mm	100 PCS	100 BAGS	45*40*35CM
-------------------------	---------	----------	------------

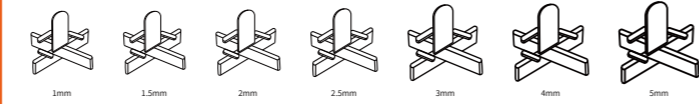

ART. 8119-4 Recyclable Tile Spacers



Recyclable Tile Spacers 1.0mm	100 PCS	100 BAGS	50*30*44CM
Recyclable Tile Spacers 1.5mm	100 PCS	100 BAGS	50*30*44CM
Recyclable Tile Spacers 2.0mm	100 PCS	100 BAGS	50*30*44CM
Recyclable Tile Spacers 2.5mm	100 PCS	100 BAGS	50*30*46CM
Recyclable Tile Spacers 3.0mm	100 PCS	100 BAGS	50*30*46CM
Recyclable Tile Spacers 4.0mm	100 PCS	100 BAGS	50*30*48CM
Recyclable Tile Spacers 5.0mm	100 PCS	100 BAGS	50*30*48CM

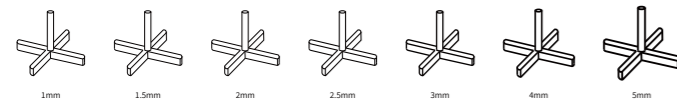

ART. 8119-7 Recyclable Tile Spacers



Recyclable Tile Spacers 1.0mm	100 PCS	100 BAGS	50*30*44CM
Recyclable Tile Spacers 1.5mm	100 PCS	100 BAGS	50*30*44CM
Recyclable Tile Spacers 2.0mm	100 PCS	100 BAGS	50*30*44CM
Recyclable Tile Spacers 2.5mm	100 PCS	100 BAGS	50*30*46CM
Recyclable Tile Spacers 3.0mm	100 PCS	100 BAGS	50*30*46CM
Recyclable Tile Spacers 4.0mm	100 PCS	100 BAGS	50*30*48CM
Recyclable Tile Spacers 5.0mm	100 PCS	100 BAGS	50*30*48CM

ART. 8119-1 Wedge-type Tile Spacers



Wedge-type Tile Spacers 1-5mm	200 PCS	100 BAGS	45*40*35CM
-------------------------------	---------	----------	------------

ART. 8119-F5 Recyclable Tile Spacers

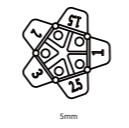

Recyclable Tile Spacers 1.0mm;1.5mm;2mm;2.5mm;3mm	100 PCS	100 BAGS	57*40*26CM
---	---------	----------	------------

ART. 8119-1U U-Shape Tile Spacers

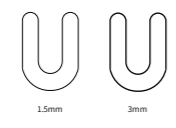

U-Shape Tile Spacers 1.5mm	100 PCS	100 BAGS	57*40*26CM
U-Shape Tile Spacers 3.0mm	100 PCS	100 BAGS	57*40*30CM

SQUARE FORMATS

cm	10 x 10	15 x 15	20 x 20	30 x 30	33 x 33	40 x 40	45 x 45	50 x 50	60 x 60	75 x 75	80 x 80	90 x 90
x m ²	100	49	25	16	13	9	9	4	4	2	2	2
x m ²	200	91	50	25	21	15	13	8	6	4	4	4

RECTANGULAR FORMATS

cm	15 x 60	15 x 90	15 x 120	20 x 40	20 x 60	20 x 80	20 x 100	25 x 100	30 x 60	30 x 90	30 x 120	40 x 80	40 x 120	45 x 90
x m ²	16	10	8	18	12	9	7	6	8	5	4	4	3	3
x m ²	26	17	13	29	19	14	12	9	16	9	6	7	5	6

LARGE SPECIAL FORMATS

cm	100 x 150	100 x 300	120 x 120	120 x 360	150 x 150	150 x 300
x m ²	2	2	2	2	2	2
x m ²	4	4	4	4	4	4



Tile Leveling System

ART. 8119-1P Tile Leveling Wedges

- High Quality PP Material.



Tile Leveling Wedges	100 PCS	20 BAGS	54*38*26CM
----------------------	---------	---------	------------



ART. 8119-2P Tile Leveling Clips

- High Quality PP Material.



Tile Leveling Clips 1.0mm	100 PCS	40 BAGS	52*40*40CM
Tile Leveling Clips 1.5mm	100 PCS	40 BAGS	52*40*40CM
Tile Leveling Clips 2.0mm	100 PCS	40 BAGS	52*40*40CM
Tile Leveling Clips 2.5mm	100 PCS	40 BAGS	52*40*40CM
Tile Leveling Clips 3.0mm	100 PCS	40 BAGS	52*40*40CM

		SQUARE FORMATS									
	cm	30 x 30	40 x 40	45x45	50x50	60x60	75x75	80x80	90x90	100x100	120x120
	x m ²	40	23	18	14	10	10	8	7	5	4

		RECTANGULAR FORMATS													
	cm	15 x 60	15 x 89	15 x 120	23 x 40	23 x 60	23 x 75	23 x 100	30 x 100	30 x 60	30 x 90	30 x 120	40 x 80	40 x 120	45 x 90
	x m ²	30	27	20	30	20	21	16	15	20	17	13	14	9	11

ART. 8119-8P Tile Leveling Plier

- Sturdy, steel construction with adjustable tension.
- Improve speed of tile laying.



Tile Leveling Plier	1 PC	50 PCS	42*42*50CM
---------------------	------	--------	------------

		EXTRA-LARGE FORMATS					
	cm	100 x 150	100x300	120x120	120x360	150x150	150x300
	x m ²	4	3	4	2	3	2



TILE LEVELING SYSTEM

Tile Leveling System

ART. 8119-8R Recyclable Tile Leveling System

- Wear-resistant and reusable.
- Suitable for 3mm to 18mm thickness of the tile.
- Made of high-quality PP plastic.



Recyclable Tile Leveling System	50 PCS	20 BAGS	52*46*33CM
---------------------------------	--------	---------	------------

ART. 8119-8R(SET) Recyclable Tile Leveling System Set

- Wear-resistant and reusable.
- Suitable for 3mm to 18mm thickness of the tile.
- Made of high-quality PP plastic.



Recyclable Tile Leveling System Set	200 PCS	12 BOXES	42*40*30CM
-------------------------------------	---------	----------	------------



SQUARE FORMATS											
cm	30 x 30	40 x 40	45x45	50x50	60x60	75x75	80x80	90x90	100x100	120x120	
x m ²	40	23	18	14	10	10	8	7	5	4	

RECTANGULAR FORMATS														
cm	15 x 60	15 x 89	15 x 120	23 x 40	23 x 60	23 x 75	23 x 100	30 x 100	30 x 60	30 x 90	30 x 120	40 x 80	40 x 120	45 x 90
x m ²	30	27	20	30	20	21	16	15	20	17	13	14	9	11

EXTRA-LARGE FORMATS						
cm	100 x 150	100x300	120x120	120x360	150x150	150x300
x m ²	4	3	4	2	3	2

Tile Leveling System

ART. 8119-TS1 Tile Leveling Screws

- The base of the screw ensures continuous tension between the screws and the caps.



Tile Leveling Screws 1.0mm	100 PCS	20 BAGS	54*44*42CM
Tile Leveling Screws 1.5mm	100 PCS	20 BAGS	54*44*42CM
Tile Leveling Screws 2.0mm	100 PCS	20 BAGS	54*44*42CM
Tile Leveling Screws 2.5mm	100 PCS	20 BAGS	54*44*42CM
Tile Leveling Screws 3.0mm	100 PCS	20 BAGS	54*44*42CM

ART. 8119-TS2 Tile Leveling Caps

- Prevents uneven tiles when laying floors, especially large format tiles.



Tile Leveling Caps	50 PCS	20 BAGS	54*44*45CM
--------------------	--------	---------	------------



SQUARE FORMATS											
cm	30 x 30	40 x 40	45x45	50x50	60x60	75x75	80x80	90x90	100x100	120x120	
x m ²	40	23	18	14	10	10	8	7	5	4	

RECTANGULAR FORMATS														
cm	15 x 60	15 x 89	15 x 120	23 x 40	23 x 60	23 x 75	23 x 100	30 x 100	30 x 60	30 x 90	30 x 120	40 x 80	40 x 120	45 x 90
x m ²	30	27	20	30	20	21	16	15	20	17	13	14	9	11

EXTRA-LARGE FORMATS						
cm	100 x 150	100x300	120x120	120x360	150x150	150x300
x m ²	4	3	4	2	3	2

GROUTING & CLEANING TOOLS

TILER Grouting & Cleaning Tools are designed to facilitate the grouting, caulking, and cleaning processes after tile installation. These tools are essential for achieving professional results, ensuring aesthetic appeal, and maintaining the cleanliness of your tiles.

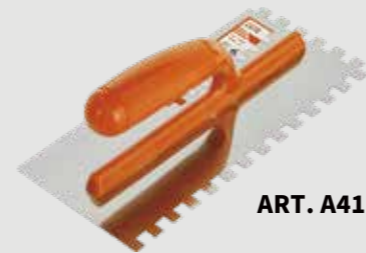

ART. A41101



ART. A41102



ART. A41103



ART. 8203F-4



- Smooth bottom surface, strong rigidity, and excellent elasticity for optimal performance.
- Easy application and uniform coverage for a professional finish.
- Rust-resistant and durable for long-lasting use.

- Durable stainless steel blade. Lightweight design.
- Square notched trowels for precise mortar application.
- Ergonomic handle, strong connection.

Trowel

NAME	ART.	Tooth		
Carbon steel Square Tooth Notched Trowel 10mm	A41101-U10	 a=10mm	6	36
Carbon steel Toothless Trowel	A41102		6	36
Carbon steel Sharp Tooth Notched Trowel	A41103	 a=15mm,b=24mm	6	36
Stainless Steel Square Tooth Notched Trowel 6mm	8203F-4-U6	 a=6mm	6	36
Stainless Steel Square Tooth Notched Trowel 8mm	8203F-4-U8	 a=8mm	6	36
Stainless Steel Square Tooth Notched Trowel 10mm	8203F-4-U10	 a=7.3mm,b=20mm,c=12mm	6	36



ART. 8203I-3-U

Grout Float

- Design for smoothly spreading grout.
- Double color soft handle.

MODEL		
8203I-3-U	/	24PCS



ART. 8203N

Grout Spreader 180mm Grout Spreader 300mm

- Design for easy and efficient grout application.
- Rubber thickness : 5mm.

MODEL		
8203N	10PCS	100/80PCS



ART. 8151-12L

Cleaning Bucket kits

- 12L bucket with wheels x1.
- Drying Rollers x1.
- Grate x1.
- Washing pad x2.

MODEL		
8151-12L	/	2PCS



ART. 8151-24L

Cleaning Bucket kits

- 24L bucket with wheels x1.
- Drying Rollers x1.
- Grate x1.
- Washing pad x2.

MODEL		
8151-24L	/	2PCS



ART. 8139-AB

Sealant Remover Kit

- 3 in 1 silicone caulking tool.
- Perfectly handles various corner issues.

MODEL		
8139-AB	/	100PCS



ART. 8137-JT

Sealant Remover Kit

- 9 different finishing profiles.
- Even in hard-to-reach places.

MODEL		
8137-JT	/	100PCS



ART. 8127-4

Cellulose Sponge

- Size : 165x110x50mm.
- 100% Cellulose.
- Ideal for all types of cleaning and decorating.

MODEL		
8127-4	/	50PCS



ART. 8127

Grout Sponge

- Size: 200x120x50mm.
- Ideal for removing excess grout.
- Clean the tile surface.

MODEL		
8127	/	50PCS



ART. 8701-M

Tile Grout Saw

- Diamond blade for long life.
- For removing old and discoloured grout.
- Replacement blades available.
- Double color TPR handle grip.

MODEL		
8701-M	15PCS	120PCS



ART. 8132

Tile Grout Saw

- TPR handle.
- Optional 1 or 2 blades.
- Diamond blades support high abrasion resistance.
- Used for removing grout.

MODEL		
8132	12PCS	60PCS



ART. 8127-3

Epoxy Grout Polishing Kit

- Kit comes with 3 different textured pads.
- Fine White Pad, Medium Red Pad, Coarse Black Pad.

MODEL		
8127-3	/	24PCS



OTHER TILING TOOLS

TILER is committed to providing installers with a comprehensive tiling solution. Our range of tools covers all the necessary equipment for every step of the tiling process, from preparation, installation, and trimming, to cleaning.

DIAMOND CERAMIC HOLE SAW

Made of high strength Carbon Steel and quality diamond abrasive particles with smooth nickel plating surface to extend the service life.

Suitable for drilling operations in ceramics, vitrified tiles, marble, granite and other materials.



ART. 8123H



ART. 8123H-SET 1

Size	Length of Shank	Overall Length	Shank Diameter	Opening depth
4MM	30MM	65MM	7.1MM	30MM
5MM	30MM	65MM	7.1MM	30MM
6MM	30MM	65MM	5.1MM	30MM
6.5MM	30MM	65MM	5.5MM	30MM
8MM	30MM	65MM	7.1MM	30MM
10MM	35MM	65MM	7.8MM	30MM
12MM	35MM	65MM	7.8MM	30MM
14MM	35MM	65MM	7.8MM	30MM
16MM	35MM	65MM	7.8MM	30MM
18MM	35MM	65MM	7.8MM	30MM
20MM	35MM	65MM	9.5MM	30MM
22MM	35MM	65MM	9.5MM	30MM
25MM	35MM	65MM	9.5MM	30MM
28MM	35MM	65MM	9.5MM	30MM
30MM	35MM	65MM	9.5MM	30MM
32MM	35MM	65MM	9.5MM	30MM
35MM	35MM	65MM	9.5MM	30MM
38MM	35MM	65MM	9.5MM	30MM
40MM	35MM	65MM	9.5MM	30MM
42MM	35MM	65MM	9.5MM	30MM
45MM	35MM	65MM	9.5MM	30MM
50MM	35MM	65MM	9.5MM	30MM
53MM	35MM	65MM	9.5MM	30MM
55MM	35MM	65MM	9.5MM	30MM
60MM	35MM	65MM	9.5MM	30MM
65MM	35MM	65MM	9.5MM	30MM
68MM	35MM	65MM	9.5MM	30MM
70MM	35MM	65MM	9.5MM	30MM
75MM	35MM	65MM	9.5MM	30MM
80MM	35MM	65MM	9.5MM	30MM
85MM	35MM	65MM	9.5MM	30MM
90MM	35MM	65MM	9.5MM	30MM
95MM	35MM	65MM	9.5MM	30MM
100MM	35MM	65MM	9.5MM	30MM
105MM	35MM	65MM	9.5MM	30MM
110MM	35MM	65MM	9.5MM	30MM
115MM	35MM	65MM	9.5MM	30MM
120MM	35MM	65MM	9.5MM	30MM



ART. 8123J

Multi-function Hole Saw Locator.

* From:φ20-83MM



ART. 8123K

Mini Hole Saw Locator.

* For:φ4,6,8,10,12MM

DIAMOND HOLE SAW SET

- Diamond Hole Saw φ 4mm
- Diamond Hole Saw φ 6mm
- Diamond Hole Saw φ 8mm
- Diamond Hole Saw φ 10mm
- Diamond Hole Saw φ 12mm



ART. 8123H-SET 2

DIAMOND HOLE SAW SET

- Diamond Hole Saw φ 20mm
- Diamond Hole Saw φ 22mm
- Diamond Hole Saw φ 30mm
- Diamond Hole Saw φ 35mm
- Diamond Hole Saw φ 40mm



ART. A21101 Tile Height Adjuster

- Suitable for Tile Lifting.
- Advantages : Fine-Tunable.

MODEL		
A21101	/	200PCS



ART. A21102 Tile Height Adjuster

- Material : Steel.
- Adjustment Range : 1-10cm.
- Load-Bearing : 100KG.
- Freely Adjustable, Easy to Operate.

MODEL		
A21102	12PCS	60PCS



ART. 8403 Hand Rasp

- Strongly-molded ABS plastic body.
- Replacement blade 140x40mm.
- Thumb screw for easy replacement.
- Perfect for smoothing uneven surfaces .

MODEL		
8403	10PCS	60PCS



ART. 8407 Hand Rasp

- Zinc-alloy body.
- Replacement blade 140x40mm.
- Perfect for smoothing uneven surfaces.

MODEL		
8407	10PCS	60PCS



ART. 8404 Hand Rasp

- Strongly-molded ABS plastic handle.
- Replacement blade 250x40mm.
- Thumb screw for easy replacement.
- Perfect for smoothing uneven surfaces.

MODEL		
8404	10PCS	60PCS



ART. 8405 Hand Rasp

- Zinc-alloy body.
- Strongly-molded ABS plastic handle.
- Replacement blade 250x40mm.
- Perfect for smoothing uneven surfaces.

MODEL		
8405	15PCS	60PCS



ART. 8126C-3 Tile Glass Mosaic Nipper

- For cutting and trimming ceramic tiles of any required shapes up to 10mm thick.
- Double color TPR handle grip.

MODEL		
8126C-3	4PCS	40PCS



ART. 8126A-N Tile Glass Mosaic Nipper

- For cutting and trimming ceramic tiles of any required shapes up to 12mm thick.
- Double color TPR handle grip.

MODEL		
8126A-N	4PCS	40PCS



ART. 8126A-O Tile Glass Mosaic Nipper

- With 2 tungsten carbide cutting wheels : Ø22xØ6x2.
- Double color TPR handle grip.

MODEL		
8126A-O	4PCS	40PCS



ART. 8107F Tile Glass Mosaic Nipper

- With a tungsten carbide cutting wheel: Ø15xØ6x1.5.
- Double color TPR handle grip.

MODEL		
8107F	4PCS	40PCS



ART. A11601 Spirit Level 60cm Spirit Level 80cm Spirit Level 100cm

- Heavy duty aluminum alloy frames.
- Horizontal, vertical and 45° bubble level.
- Strong magnetic.

MODEL		
A11601	/	30PCS



ART. A21501 5m Tape Measure

- ABS Shockproof Case, Orange Coated Rubber.
- Automatic locking, press to retract.

MODEL		
A21501	12PCS	120PCS



ART. 8122 Contour Gauge 6" Contour Gauge 10"

- Made of premium ABS plastic, very durable and sturdy.
- Perfect for use in wood cataloging moulding.

MODEL		
8122	/	50PCS



ART. 8702-M Tile Scribe

- Tungsten blade.
- Easy to operate.
- Double color TPR handle grip.

MODEL		
8702-M	10PCS	100PCS

ART. A71101

Rubber Mallet 8oz
Rubber Mallet 12oz
Rubber Mallet 16oz
Rubber Mallet 24oz
Rubber Mallet 32oz



- Rubber head.
- TPR handle.
- No damage to the tiles.

MODEL		
A71101	/	12PCS



ART. A81101

Heavy Duty Tile Beater

- Size : 355 x 146mm.
- Remove air from under the tile.
- Heavy duty rubber pad.

MODEL		
A8203D	/	12PCS

ART. A91102

Diamond Disc 105



- professional level.
- Size : Ø105xØ20x1.2mm.
- For both wet and dry cutting.
- Made with premium diamond particles.
- Compatible with most electric tile cutters.
- For stone, marble, granite, porcelain and ceramics.

MODEL		
A91102	20PCS	200PCS

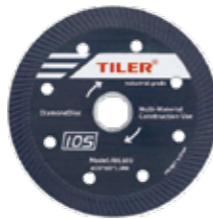

ART. A91103

Diamond Disc 105

- Industrial level.
- Size : Ø105xØ20x1.1mm.
- For both wet and dry cutting.
- Made with premium diamond particles.
- Compatible with most electric tile cutters.
- For stone, marble, granite, porcelain and ceramics.

MODEL		
A91103	20PCS	200PCS

ART. Y31101

Diamond Hand Pad Grain # 60
Diamond Hand Pad Grain # 100
Diamond Hand Pad Grain # 200
Diamond Hand Pad Grain # 400



- Diamond + High Hardness High Elasticity Sponge.
- Works great for granite, engineered stone, glass, concrete, marble etc.

MODEL		
Y31101	/	50PCS





ART. ZJ01
TILER shelf

- Made of Iron.
- Professional shelves with exquisite appearance, sturdy and durable.
- High space utilization.
- Designed specifically for TILER tools to improve sales efficiency.
- Become an agent of the TILER brand and have the opportunity to get shelves for free.
- Customizable size according to site requirements.

MODEL		
ZJ01	/	1 SET in 2 CTN.

DISTRIBUTION

We Are Warmly Welcome Business Partners Worldwide to Join TILER Distributors and Lead the Tiling Tools Industry Together.

Technical

Trusted

Tenacious

Thrive

Talented

Technical

Trusted

Tenacious

Thrive

Talented



Instagram



Facebook



YouTube



www.tilertool.com



info@tilertool.com



+86-571-88637866



Hangzhou John Hardware Tools CO.,Ltd



No.5 Lvtai Road,Zhongtai Industrial Zone,Yuhang,Hangzhou,Zhejiang,China