

TILER®

CATALOG

SINCE 1996

2024



| MAKE TILING EASY |

TILER[®]

1	ABOUT TILER	
2	TILE CUTTING MACHINE	
	Manual tile cutters	09
	Accessories for tile cutters	19
3	LARGE FORMAT SLAB SYSTEM	
	Cutters for large format slab	21
	Workbench for large format slab	25
	Handling system for large format slab	28
	Trolley for large format slab	31
	Accessories for large format slab system	33
4	FLOOR CUTTING MACHINE	
	Floor cutting machine	34
5	TILE CARRYING & LAYING TOOLS	
	Tile vibration machine	37
	Vacuum suction cup	39
	Aluminum suction cup	39
6	TILE LEVELING TOOLS	
	Tile spacers	42
	Tile leveling system	45
7	GROUTING & CLEANING TOOLS	
	Grouting tools	49
	Cleaning tools	51
8	OTHER TILING TOOLS	
	Other tiling tools	53

ABOUT TILER



First Tile Cutter
Exported to Poland

Became Global Sales Leader
in Tile Cutting Machines

Dedicated to Recruit
TILER Distributors Worldwide

HangZhou John Hardware
Tools Co., LTD. Established

Interviewed by
National China Central Television
(CCTV)

A Top-Level Tile Cutting Machine
Was Designed in Collaboration with
German Experts



Company Profile

30+ years

Industry Experience

130+

Countries

For Every **5** Tile Cutting Machines Sold Globally

1 was Produced by TILER

40,000+ m²

Workshop

30 days

Delivery Time

Patent

71

Core technology invention patents

8

Granted invention patents

38

Utility model patents

25

Design patents



Certificate



ORIGINAL MANUFACTURER



PRODUCT CONCEPT

Precise: TILER's commitment to precision ensures that you achieve flawless results with every performance. We understand the importance of accuracy in your work, so TILER products are meticulously designed and crafted to deliver consistent and precise outcomes. Whether you're a professional in a specialized field or an enthusiast pursuing your passion, TILER products will empower you to achieve the highest level of precision in your endeavors.

Innovative: Stay ahead and upgrade your work with innovative technology. TILER continuously push the boundaries of innovation to bring you cutting-edge tools that enhance your capabilities and unleash your creativity. TILER's commitment to innovation drives us to explore new possibilities, develop groundbreaking solutions, and integrate the latest advancements into TILER products. Embrace the power of innovation and unlock a world of endless possibilities in your work.

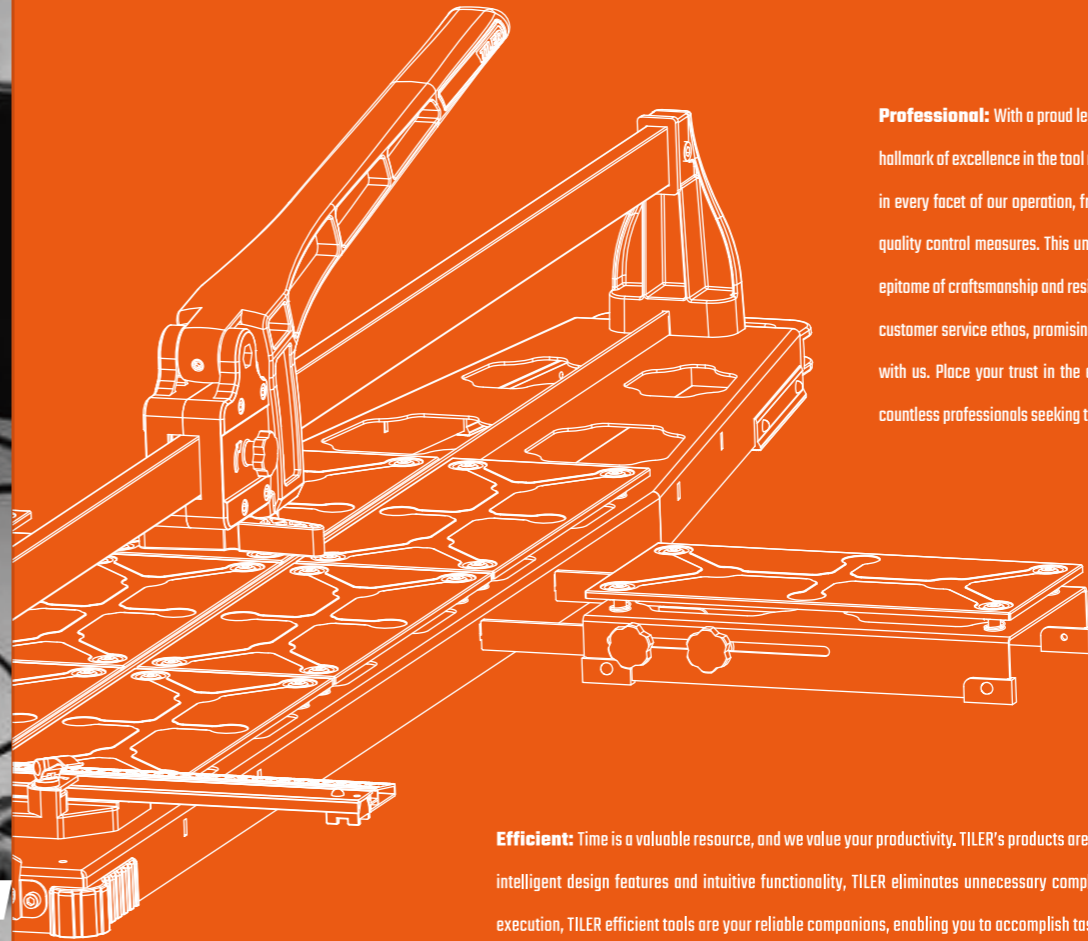

Professional: With a proud legacy spanning over 30 years, TILER has carved a niche for itself as a hallmark of excellence in the tool manufacturing industry. Our dedication to professionalism is evident in every facet of our operation, from the meticulous selection of superior materials to our stringent quality control measures. This unwavering commitment ensures that every TILER tool embodies the epitome of craftsmanship and resilience. Furthermore, our devotion to professionalism permeates our customer service ethos, promising you a smooth and supportive experience throughout your journey with us. Place your trust in the expertise and experience that have made us the go-to choice for countless professionals seeking to elevate their work to new heights of excellence.

Efficient: Time is a valuable resource, and we value your productivity. TILER's products are engineered to help you complete projects quickly and easily. With intelligent design features and intuitive functionality, TILER eliminates unnecessary complexities and streamline your workflow. From project planning to execution, TILER efficient tools are your reliable companions, enabling you to accomplish tasks with optimal efficiency and effectiveness.



ABOUT TILER

"TILER" is a high-end brand dedicated to manufacturing tile cutting and installation tools. As an independent brand created by Hangzhou John Hardware Tools Co., Ltd., its parent company, TILER has been committed to providing global users with high-quality and high-efficiency tiling tools. Since the development of the first tile cutting machine, the company has continuously innovated, accumulated experience, and consistently strived to deliver professional tile cutting and installation tools.

With 30 years of innovative research and development technology and efficient production capabilities, TILER has become a leader in the global tiling tools industry, serving customers in over 130 countries and maintaining the top global sales of tile cutting machines for 10 consecutive years.

TILER is renowned for its craftsmanship spirit. Constantly Pursuing excellence in quality at its core. The brand is dedicated to manufacturing each product with efficiency, precision, professionalism, innovation, and safety as its guiding principles. Through advanced design, high-quality products, and customized services, TILER provides every user with an enjoyable tile installation experience. Whether you are a professional or a DIY installer, you can find satisfactory solutions in the products and services offered by TILER.

MISSION

We are committed to providing installers with high-quality and high-efficiency tools for cutting and laying tiles, while creating a "resource-saving and environmentally friendly" living environment for humanity.

VISION

To become a respected global century-old enterprise in the tiling tools industry.

TILE CUTTING MACHINE

TILER Tile Cutters are available in various models to cater to different needs. They feature metal alloy materials as well as aluminum alloy materials, and come with both single-rail sliding system and double-rail sliding system. We offer machines suitable for standard tile sizes such as 24 inches and 32 inches, as well as machines designed for large-sized tiles like 72 inches or even up to 144 inches. We have options suitable for DIY installers as well as machines specifically designed for professional installers.

TILER not only provides tile cutters but also offers comprehensive technical support and after-sales service. We are committed to establishing long-term partnerships with our customers, working together to drive the development of the tile industry and providing high-quality cutting solutions to users.



SPEEDY ROCKET TILE CUTTER

8102G-3Y



1050-1550 mm
CUTTING ANGLE 0-60°
18 mm (max)
1200 KG
22x6x6 mm YG-6X
Ti COATED



Robust wide base, guide, and breaking system.



Extended labor-saving handle.



Spring pads with shock absorber for better tile breaking.



80cm aluminum adjustable gauge for fast and accurate measurement.



Heavy-duty extension feet with spring pads for supporting large size tile.

MANUAL TILE CUTTERS

MODEL	SIZE			
8102G-3Y-1050	42"	1050mm	740mm	18mm
8102G-3Y-1300	52"	1300mm	920mm	18mm
8102G-3Y-1550	62"	1550mm	1095mm	18mm
ø22*ø6*6mm	1PC/CTN	27KG	136*35.5*28.5CM	
ø22*ø6*6mm	1PC/CTN	32KG	161*35.5*28.5CM	
ø22*ø6*6mm	1PC/CTN	35.5KG	186*35.5*28.5CM	

PREM. RAPTOR TILE CUTTER

8102G-T3



1200-1800 mm	CUTTING ANGLE 45°/90°	16 mm (max)	1200 KG
22x6x6 mm YG-6X	Ti COATED	LASER	



Patented lockable breaker for visible cutting performance.



Aluminum gauge, beautiful and precise.



Equipped with infrared laser for more precise cutting.



Extended labor-saving handle, ergonomic and heavy-duty construction.



Fully enclosed and self-adjusting sliding system.

MODEL	SIZE			
8102G-T3-1200	48"	1200mm	850mm	16mm
8102G-T3-1600	64"	1600mm	1130mm	16mm
8102G-T3-1800	72"	1800mm	1270mm	16mm
∅22*∅6*6mm	1PC/CTN	18KG	153*17.5*26CM	
∅22*∅6*6mm	1PC/CTN	28KG	193*17.5*26CM	
∅22*∅6*6mm	1PC/CTN	30KG	213*17.5*26CM	

RAPTOR TILE CUTTER

8102G-2GH



800-1200 mm	CUTTING ANGLE 45°/90°	16 mm (max)	1000 KG
	22x6x6 mm YG-6X	Ti COATED	LASER



Fully enclosed slider, dust-free and no adjustment needed.

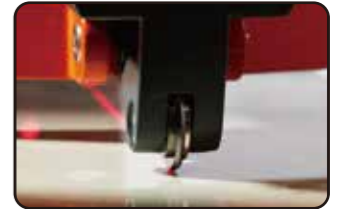

TILER premium cutting wheel, long-lasting life.



Patented lockable breaker for visible cutting performance.



Hidden extension feet for large tiles and easy carrying.



Equipped with infrared laser for more precise cutting.

MODEL	SIZE			
8102G-2GH-800	32"	800mm	565mm	16mm
8102G-2GH-1000	40"	1000mm	705mm	16mm
8102G-2GH-1200	48"	1200mm	850mm	16mm
ø22*ø6*6mm	1PC/CTN	12.5KG	113*17.5*26CM	
ø22*ø6*6mm	1PC/CTN	15KG	133*17.5*26CM	
ø22*ø6*6mm	1PC/CTN	18KG	155*17.5*26CM	

LIGHTNING TILE CUTTER

8102G-2A-DJH



- Handle with soft grip for better ergonomics and comfort.
- Aluminum base for robustness, light and easy to transport.
- Comes with 2 extra aluminum extension feet for large tiles.
- Reinforced guide, greater bending resistance and increased precision.
- 80cm aluminum adjustable gauge for fast and accurate measurement.
- Guide system highly resistant to impacts resulting in longer product life.
- Patented lockable breaker with plastic protector, ensuring better visibility of scoring and cutting zone.

MODEL	SIZE			
8102G-2A-DJH-900	36"	900mm	635mm	16mm
8102G-2A-DJH-1200	48"	1200mm	850mm	16mm
8102G-2A-DJH-1550	62"	1550mm	1095mm	16mm
∅22*∅6*6mm	2PC/CTN	20KG	116*25*26CM	
∅22*∅6*6mm	1PC/CTN	14KG	146*25*26CM	
∅22*∅6*6mm	1PC/CTN	18KG	181*25*26CM	



900-1550 mm	CUTTING ANGLE 0-60°	16 mm (max)	1000 KG
	22x6x6 mm YG-6X	Ti COATED	Al

UNIVERSAL TILE CUTTER

8102G-3B



- Magnetic breaker provides direct view of scoring line.
- Fast operating system with magnet, for one-hand use.
- Handle with soft grip for better ergonomics and comfort.
- Wide base surface for higher stability and cutting quality.
- Heavy-duty metal extension feet for excellent tile placement.
- Reinforced supporters for heavy-duty work, and high durability.
- The adjustable aluminum gauge provides greater precision in angle cuts.

MODEL	SIZE			
8102G-3B-600	24"	600mm	425mm	14mm
8102G-3B-800	32"	800mm	565mm	14mm
∅22*∅6*6mm	2PC/CTN	15KG	86*20*49CM	
∅22*∅6*6mm	2PC/CTN	18KG	106*20*49CM	



600-800 mm	CUTTING ANGLE 0-60°	14 mm (max)	800 KG
	22x6x6 mm YG-6X	Ti COATED	



NAME	MODEL	INCH	 mm	 mm	 mm	 kgs	 mm	 mm	
									ADJUSTABLE FROM 0° - 60°
	8102G-3Y-1050	42"	1050	742	18	1200	ø22*ø6*6		✓
	8102G-3Y-1300	52"	1300	920					✓
	8102G-3Y-1550	62"	1550	1095					✓
	8102G-T3-1200	48"	1200	850	16	1000	ø22*ø6*6		✓
	8102G-T3-1600	64"	1600	1130					✓
	8102G-T3-1800	72"	1800	1270					✓
	8102G-2GH-800	32"	800	565	16	1000	ø22*ø6*6		✓
	8102G-2GH-1000	40"	1000	705					✓
	8102G-2GH-1200	48"	1200	850					✓
	8102G-2A-DJH-900	36"	900	635	16	1000	ø22*ø6*6		✓
	8102G-2A-DJH-1200	48"	1200	850					✓
	8102G-2A-DJH-1550	62"	1550	1095					✓
	8102G-3B-600	24"	600	425	14	800	ø22*ø6*6		✓
	8102G-3B-800	32"	800	565					✓



8117-22X6X6

CUTTING WHEEL

- Size : Ø22xØ6x6mm.
- High-quality replaceable accessory for TILER manual tile cutters.
- Maximum cutting length of 2000m.
- Crafted from premium tungsten carbide material.

MODEL		
8117-22*6*6	100PCS	300PCS



8117-22X6X6T

TITANIZE CUTTING WHEEL

- Size : Ø22xØ6x6mm.
- High-quality replaceable accessory for TILER manual tile cutters.
- Maximum cutting length of 2000m.
- Crafted from premium tungsten carbide material and features a special titanize coating.

MODEL		
8117-22*6*6T	100PCS	300PCS

SCORING WHEEL	ART	NAME				APPLICABLE
	8117-22X6X6	CUTTING WHEEL	22mm	6mm	6mm	8102G-3Y 8102G-T3 8102G-2GH
	8117-22X6X6T	TITANIZE CUTTING WHEEL	22mm	6mm	6mm	8102G-2A-DJH 8102G-3B

LARGE FORMAT SLAB SYSTEM

Large format slabs are expensive, and their large size increases the difficulty of handling them, as well as the risk of damage. To address these issues, TILER has developed and designed a complete range of products specifically tailored for large format slabs. The TILER Large Format Slab System is designed to ensure the safe and efficient handling of slabs throughout the installation process. This includes workbenches that can accommodate large format slabs, as well as manual and electric cutting machines specifically designed for cutting large format slabs, catering to the cutting needs of installers working with various thicknesses of tiles. In addition, there are equipments available for efficient and effortless transportation of large format slab tiles.

DB-3/3200

PREM. LARGE FORMAT SLAB CUTTER



CUTTERS FOR LARGE FORMAT SLAB

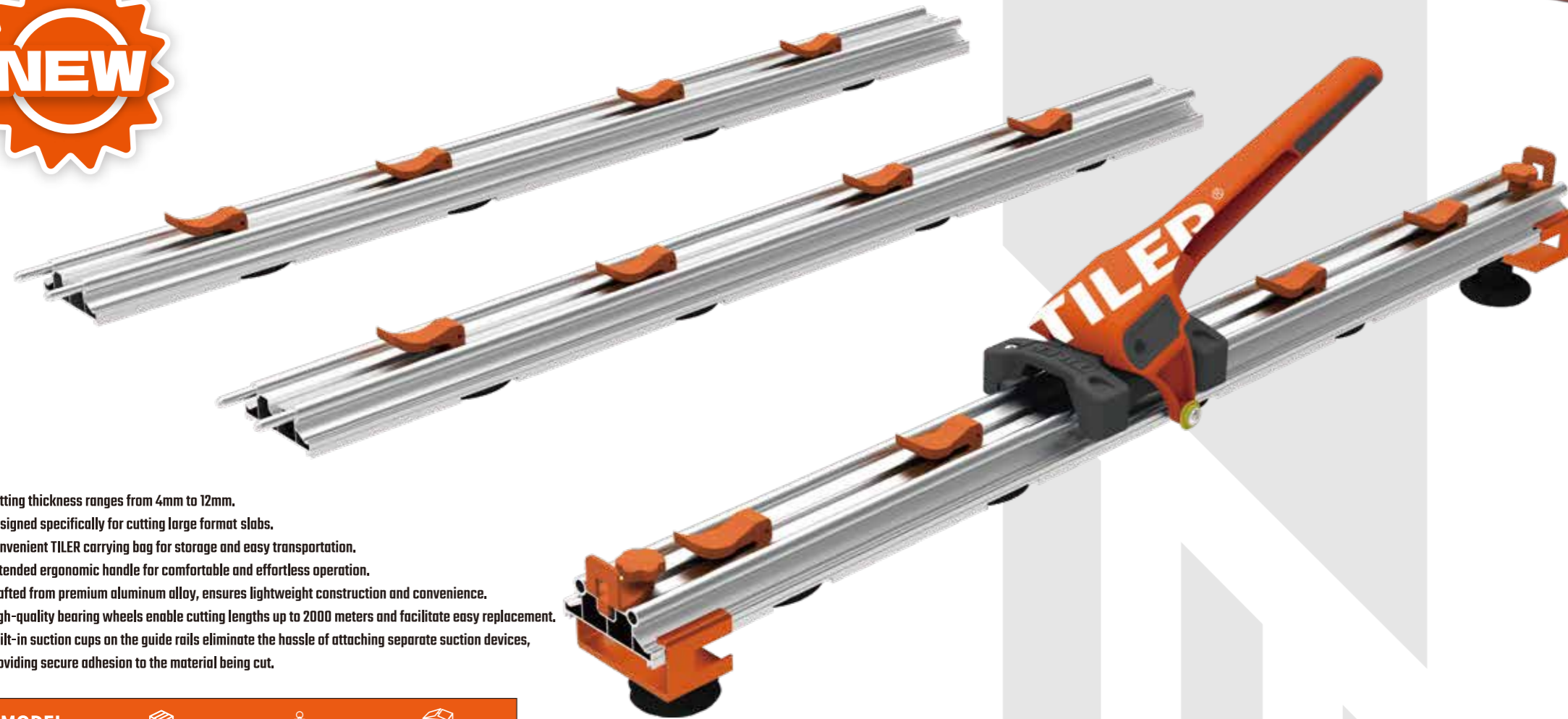

- Cutting thickness ranges from 4mm to 12mm.
- Designed specifically for cutting large format slabs.
- Convenient TILER carrying bag for storage and easy transportation.
- Extended ergonomic handle for comfortable and effortless operation.
- Crafted from premium aluminum alloy, ensures lightweight construction and convenience.
- High-quality bearing wheels enable cutting lengths up to 2000 meters and facilitate easy replacement.
- Built-in suction cups on the guide rails eliminate the hassle of attaching separate suction devices, providing secure adhesion to the material being cut.

GUIDE RAILS CAN BE FLEXIBLY COMBINED TO ACCOMMODATE DIFFERENT DIMENSIONS.

YOU HAVE THE OPTION TO CHOOSE FROM: 1800MM AND 3200MM.

MODEL			
DB-3/3200	1SET	8KG	150*20*30CM

3200 mm	FAST LIGHT	
	22x6x6 mm YG-6X	Ti COATED
		1000 KG

DE-125X

ELECTRIC & MANUAL CUTTER 2 IN 1 KIT



- Includes 125mm & 115mm Diamond disc.
- The manual cutting system can cut up to 12mm.
- The electric cutting system can cut up to 23mm.
- Double dust reduction/control system. Dry and wet cutting.
- Comes with a TILER carry bag for easy storage and handling.
- Switch with safety lock. Prevents unintentional start-up. Electrical cable with PRCD.
- The cutting head is height-adjustable and hinged, allowing for angles ranging from 0° to 48°.
- Comprising 3 assembled extruded aluminum guides, this system enables flawless scoring in large format tiles up to 360cm, resulting in precise and smooth cuts.

MODEL			
DE-125X	1SET	15.6KG	136*11*12.8CM(Accessories) 35.5*30*25.8CM(Host Engine)

3600+ mm	BEVEL CHAMFER	 (220V/110V)	 1.4kW
 125/115 mm		23 mm (max)	13800 RPM



DB-TB-3/3600

LARGE FORMAT SLAB WORKBENCH 3600MM

WORKBENCH FOR LARGE FORMAT SLAB

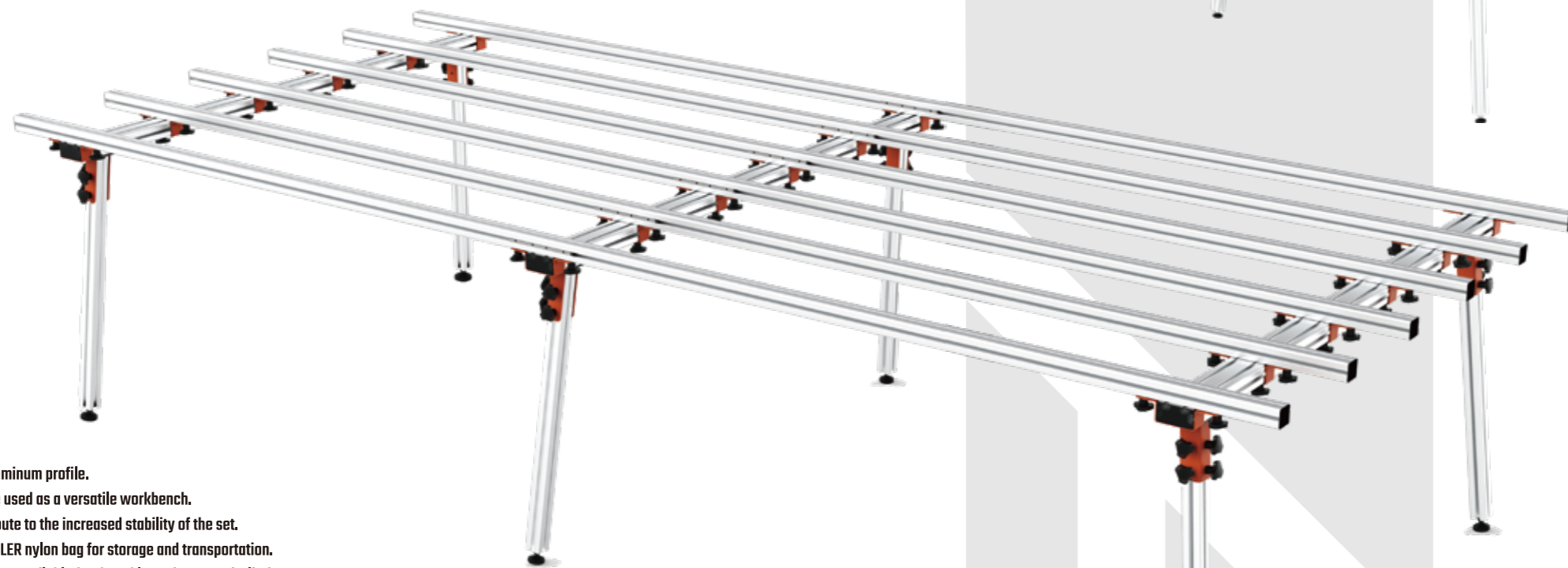

- Rigidity high-quality aluminum profile.
- Multi-functional, can be used as a versatile workbench.
- The leveling feet contribute to the increased stability of the set.
- Comes with a durable TILER nylon bag for storage and transportation.
- Customization options are available for the table surface's anti-slip feature.
- Fast and easy assembly and disassembly with a convenient fixed connection system.
- The extra-reinforced aluminum bars give the Slab workbench a lightweight, high rigidity, and great stability.
- The separation of its 12 aluminum bars allows the user to make perforations and cuts without fear of damaging the table itself.

MODEL			
DB-TB-3/3600	1SET	47.7KG	183*22*27CM

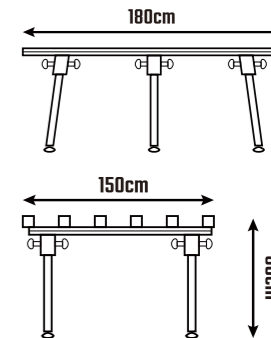

DB-TB-3/1800

MODEL			
DB-TB-3/1800	1SET	38KG	183*26.5*20.5CM

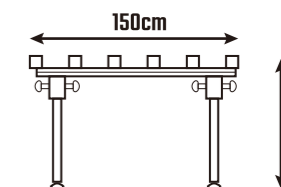
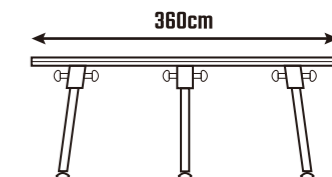

DB-TB-4

LARGE FORMAT SLAB CENTIPEDE WORKBENCH (15LEGS)



Expanded size: 221*113*73 cm
87*45*29 inch

- Reinforced aluminum profile structure.
- Compressive load capacity: 1000KG.
- Quick folding and storage, ready to use without installation.
- Lightweight and easy to carry.
- Comes with a durable nylon carrying bag for convenient storage and portability.

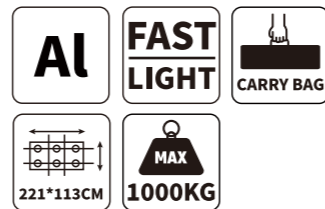

MODEL			
DB-TB-4	1SET	13KG	94*38.5*24CM

DB-CY-2

LARGE FORMAT SLAB HANDLING SYSTEM

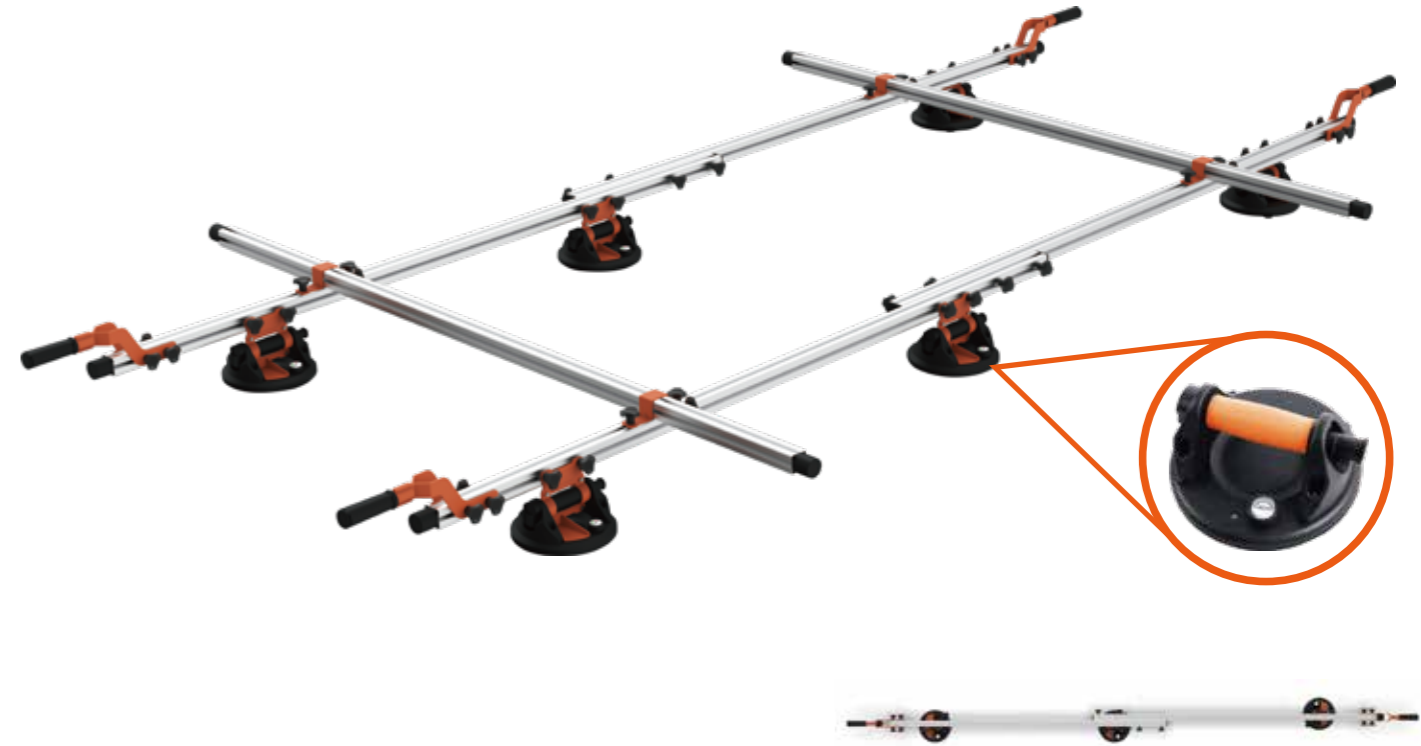

GREAT FOR LONG NARROW SLABS

- Reinforced aluminum profile. Greater structural strength.
- The crossbars can be easily released for transporting long narrow slabs.
- The set includes 2 retractable and adjustable extruded aluminum guides (160-360cm).
- Equipped with 6 heavy-duty vacuum cups, the system stays firmly fixed.
- These suction cups are easily positionable and allow for adjustable fixing points, ensuring the safe handling of large format sheets.

MODEL			
DB-CY-2	1SET	29KG	193*25.5*22.5CM

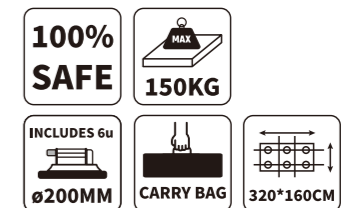

HANDLING SYSTEM FOR LARGE FORMAT SLAB

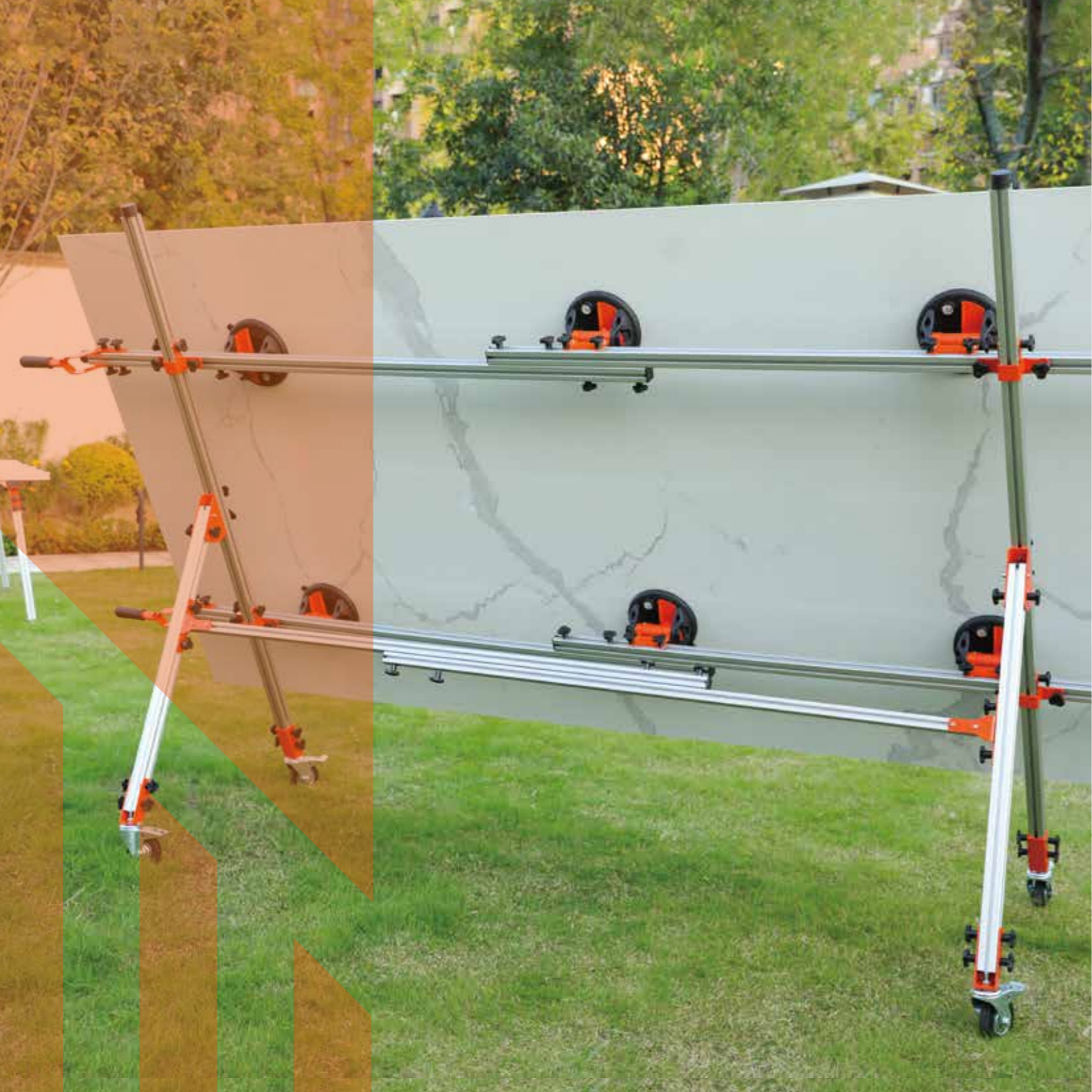

DB-CY-3





PORTABLE LARGE FORMAT SLAB HANDLING SYSTEM



- Reinforced aluminum profile. Greater structural strength.
- Comes with 2 detachable and foldable support legs allow the system to stand upright.
- Consists of two retractable and adjustable extruded aluminum guides, ranging from 160 to 360 cm.
- The system is equipped with 6 heavy-duty vacuum suction cups that securely fix the system in place.
- These suction cups are easily positionable and allow for adjustable fixing points, ensuring the safe handling of large format sheets.

GREAT FOR LONG NARROW SLABS

MODEL			
DB-CY-3	1SET	42.5KG	193*27.5*30CM

100% SAFE	 150KG	 CARRY BAG
INCLUDES 6x Ø200MM	 360° SPIN AND BRAKE	 360*160CM
		 STAND UPRIGHT

DB-TU-2

LARGE FORMAT SLAB TROLLEY



- Ultra light and compact.
- Especially suitable for thicker/heavier slabs.
- Equipped with four 360° swivel casters with integrated braking and locking system.
- Easy and quick to assemble and disassemble. Easy fix connection system.
- Designed with a collapsible base and a durable carrying bag for easy storage and portability.
- Ergonomic extendable support arm for easier loading/unloading on the workbench.

MODEL			
DB-TU-2	1SET	22.8KG	144*26*20CM



TROLLEY FOR LARGE FORMAT SLAB

	NAME	MODEL	WORKING RANGE	SLAB INFORMATION REFERENCE
	SLAB CUTTER	DB-3/3200	3200MM+	
	SLAB CUTTER	DE-125X	3600MM+	
	WORKBENCH	DB-TB-3	3600MM+	
	WORKBENCH	DB-TB-4	2400MM+	
	HANDLING SYSTEM	DB-CY-2	3200MM+	
	HANDLING SYSTEM	DB-CY-3	3200MM+	
	TROLLEY	DB-TU-2	3600MM+	

8117-22X6X6

CUTTING WHEEL



- Size : Ø22xØ6x6mm.
- High-quality replaceable accessory for TILER manual tile cutters.
- Maximum cutting length of 2000m.
- Crafted from premium tungsten carbide material.

MODEL	100PCS	300PCS
8117-22*6*6		



DE-D125

DIAMOND DISC 125

- Professional level.
- Size : Ø125xØ22.23x1mm.
- For both wet and dry cutting.
- Made with premium diamond particles.
- Compatible with most electric tile cutters.
- For stone, marble, granite, porcelain and ceramics.

MODEL	20PCS	200PCS
DE-D125		

8117-22X6X6T

TITANIZE CUTTING WHEEL



- Size : Ø22xØ6x6mm.
- High-quality replaceable accessory for TILER manual tile cutters.
- Maximum cutting length of 2000m.
- Crafted from premium tungsten carbide material and features a special titanize coating.

MODEL	100PCS	300PCS
8117-22*6*6T		



DE-D115

DIAMOND DISC 115

- Professional level.
- Size : Ø115xØ22.23x1mm.
- For both wet and dry cutting.
- Made with premium diamond particles.
- Compatible with most electric tile cutters.
- For stone, marble, granite, porcelain and ceramics.

MODEL	20PCS	200PCS
DE-D115		

SCORING WHEEL	ART	NAME	Ø	Ø	Ø	APPLICABLE
	8117-22X6X6	CUTTING WHEEL	22mm	6mm	6mm	DB-3/3200,DE-125X
	8117-22X6X6T	TITANIZE CUTTING WHEEL	22mm	6mm	6mm	DB-3/3200,DE-125X
	DE-D125	DIAMOND DISC 125	125mm	22.23mm	1mm	DE-125X
	DE-D115	DIAMOND DISC 115	115mm	22.23mm	1mm	DE-125X

FLOOR CUTTING MACHINE

TILER Floor Cutter is a versatile tool designed for effortless cutting of various flooring materials. With its sturdy construction and alloy steel blade, it ensures smooth operation and precise cuts. Upgrade your cutting capabilities with TILER Floor Cutter, the ideal choice for professionals and DIY enthusiasts.



8503-160 FLOOR CUTTER

- Max. cutting thickness: 16mm.
- Max. cutting width: 300mm.
- Cutting type: straight cutting /0-90° angle cutting.
- Cutting flexible or resilient flooring materials: wood flooring, laminate flooring, vinyl flooring, LVP, SPC, WPC, VCT etc.

MODEL			
8503-160	1PC	12.6KG	55*26*29CM

8503-120 FLOOR CUTTER

- Max. cutting thickness: 12mm.
- Max. cutting width: 300mm.
- Cutting type: straight cutting /0-90° angle cutting.
- Cutting flexible or resilient flooring materials: wood flooring, laminate flooring, vinyl flooring, LVP, SPC, WPC, VCT etc.

MODEL			
8503-120	1PC	11KG	53*24*29CM



TILE CARRYING & LAYING TOOLS

TILER Tile Carrying & Laying Tools are meticulously designed to optimize workflow, increase productivity, and elevate the overall tiling experience. Our commitment to quality and innovation empowers professionals to achieve exceptional results, while reducing the time and effort required for tile installation.

8190-AT

TILE VIBRATION MACHINE 20V



- Vibrator Cup Diameter : 190MM
- Battery Capacity : 2000mA
- Battery Voltage : 20V
- Charging Current : 1.5 A
- Battery Charging Time : 2h
- Vibration Frequency : 0-10000r/min
- Vertical Suction : 50KG

- TILER tile vibration machine is a specialized tool used for leveling and setting tiles during installation.
- The machine uses vibrations to distribute the tile adhesive evenly and remove any air pockets or voids between the tile and substrate, resulting in a flat and level surface.



MODEL		
8190-AT	1PC	6PCS

8123-BDC

Tile Vibration Machine 16V

- Vibrator Cup Diameter : 130MM
- Battery Capacity : 2000mA
- Battery Voltage : 16V
- Charging Current : 1.5 A
- Battery Charging Time : 2h
- Vibration Frequency : 0-10000r/min
- Vertical Suction : 50KG
- Fast Speed Regulation, Powerful Vibration.
- One-Button Start, 12-speed variable
- Fast Tile Laying.

MODEL		
8123-BDC	1PC	6PCS



8123-DC

Tile Vibration Machine 20V

- Vibrator Cup Diameter : 130MM
- Battery Capacity : 2000mA
- Battery Voltage : 20V
- Charging Current : 1.5 A
- Battery Charging Time : 2h
- Vibration Frequency : 0-10000r/min
- Vertical Suction : 50KG
- Fast Speed Regulation, Powerful Vibration.
- Extended Battery Life, One-Button Start.
- Fast Tile Laying.

MODEL		
8123-DC	1PC	6PCS



8123-GD

Tile Vibration Machine 20V

- Vibrator Cup Diameter : 190MM
- Battery Capacity : 2000mA
- Battery Voltage : 20V
- Charging Current : 1.5 A
- Battery Charging Time : 2h
- Vibration Frequency : 0-16000r/min
- Vertical Suction : 50KG
- Adjustable vibration intensity with 9 levels.
- Extended Battery Life, One-Button Start.
- Fast Tile Laying.

MODEL		
8123-GD	1PC	6PCS





8128F-EN
Electric Vacuum Suction Cup 8"

- Automatically turn on/off pump
- Durable nitrile rubber.
- Diameter : 210mm/8".
- Load capacity : 200kg.
- 2 detachable 2*1200mAh Li-ion batteries.
- With pressure gauge for safe indication.
- Suitable for smooth and rough tiles.



MODEL	Icon 1	Icon 2
8128F-EN	1PC	6PCS



8128F-EB
Electric Vacuum Suction Cup 8"

- Automatically turn on/off pump.
- Durable nitrile rubber.
- Diameter : 210mm/8".
- Load capacity: 200 kg.
- 2 detachable 2*1200mAh Li-ion batteries.
- Suitable for smooth and rough tiles.



MODEL	Icon 1	Icon 2
8128F-EB	1PC	6PCS



8128F-AW
Vacuum Suction Cup 8"

- Durable nitrile rubber.
- Diameter : 210mm/8".
- Load capacity : 200kg.
- Suitable for smooth and rough tiles.
- Detachable and replaceable pump.
- Equipped with pressure gauge for safe indication.



MODEL	Icon 1	Icon 2
8128F-AW	1PC	6PCS



8128F-A
Vacuum Suction Cup 8"

- Durable nitrile rubber.
- Diameter : 210mm/8".
- Load capacity : 200kg.
- Suitable for smooth and rough tiles.
- Detachable and replaceable pump.



MODEL	Icon 1	Icon 2
8128F-A	1PC	6PCS



8128F-2
Vacuum Suction Cup 8"

- Durable nitrile rubber.
- Diameter : 200mm/8".
- Load capacity : 150 kg.
- Equipped with pressure gauge for safe indication.
- Suitable for smooth and rough tiles.
- Detachable and replaceable pump.



MODEL	Icon 1	Icon 2
8128F-2	1PC	6PCS



8128F-3
Pro. Vacuum Suction Cup 8"

- Durable nitrile rubber.
- Diameter : 210mm/8" .
- Load capacity : 200kg.
- Equipped with pressure gauge for safe indication.
- Suitable for smooth and rough tiles.
- Detachable and replaceable pump.



MODEL	Icon 1	Icon 2
8128F-3	1PC	6PCS



8128-1 Single Aluminum Suction Cup

- Material : Nitrile Rubber
- Diameter : 123MM
- Load capacity : 50KG

MODEL		
8128-1	1PC	10PCS



8128-2 Double Aluminum Suction Cup

- Material : Nitrile Rubber
- Diameter : 123MM
- Load capacity : 80KG

MODEL		
8128-2	1PC	10PCS



8128-3 Triple Aluminum Suction Cup

- Material : Nitrile Rubber
- Diameter : 123MM
- Load capacity : 100KG

MODEL		
8128-3	1PC	10PCS



8128-7 Adjustable Suction Cup

- Material : Nitrile Rubber
- Diameter : 123MM
- Load capacity : 100KG

MODEL		
8128-7	1PC	12PCS

TILE LEVELING TOOLS

TILER Tile Leveling Tools offer a suite of innovative solutions for flawless tile installations, featuring perfect leveling and precise grout spacing. These essential tools guarantee professional outcomes, eliminate lippage, and achieve a seamless finish in all tiling projects.

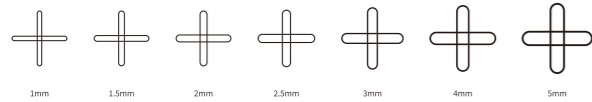

8119-3

X-type Tile Spacers



Size	PCS	BAGS	Dimensions
X-type Tile Spacers 1.0mm	200 PCS	100 BAGS	38*20*18CM
X-type Tile Spacers 1.5mm	200 PCS	100 BAGS	38*20*18CM
X-type Tile Spacers 2.0mm	200 PCS	100 BAGS	38*20*20CM
X-type Tile Spacers 2.5mm	200 PCS	100 BAGS	38*20*20CM
X-type Tile Spacers 3.0mm	200 PCS	100 BAGS	38*20*22CM
X-type Tile Spacers 4.0mm	100 PCS	100 BAGS	48*22*22CM
X-type Tile Spacers 5.0mm	100 PCS	100 BAGS	48*22*24CM

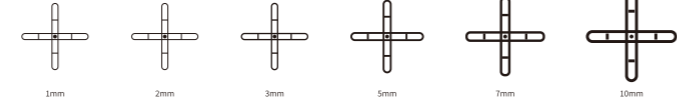

8119-6

Hollow Tile Spacers



Size	PCS	BAGS	Dimensions
Hollow Tile Spacers 1mm	200 PCS	100 BAGS	38*20*18CM
Hollow Tile Spacers 2mm	200 PCS	100 BAGS	38*20*18CM
Hollow Tile Spacers 3mm	200 PCS	100 BAGS	38*20*20CM
Hollow Tile Spacers 5mm	100 PCS	100 BAGS	45*40*35CM
Hollow Tile Spacers 7mm	100 PCS	100 BAGS	45*40*40CM
Hollow Tile Spacers 10mm	100 PCS	100 BAGS	45*40*50CM

8119-2

T-type Tile Spacers

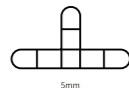

Size	PCS	BAGS	Dimensions
T-type Tile Spacers 5mm	100 PCS	100 BAGS	45*40*35CM



8119-7

Recyclable Tile Spacers



Size	PCS	BAGS	Dimensions
Recyclable Tile Spacers 1.0mm	100 PCS	100 BAGS	50*30*44CM
Recyclable Tile Spacers 1.5mm	100 PCS	100 BAGS	50*30*44CM
Recyclable Tile Spacers 2.0mm	100 PCS	100 BAGS	50*30*44CM
Recyclable Tile Spacers 2.5mm	100 PCS	100 BAGS	50*30*46CM
Recyclable Tile Spacers 3.0mm	100 PCS	100 BAGS	50*30*46CM
Recyclable Tile Spacers 4.0mm	100 PCS	100 BAGS	50*30*48CM
Recyclable Tile Spacers 5.0mm	100 PCS	100 BAGS	50*30*48CM



8119-4

Recyclable Tile Spacers



Size	PCS	BAGS	Dimensions
Recyclable Tile Spacers 1.0mm	100 PCS	100 BAGS	50*30*44CM
Recyclable Tile Spacers 1.5mm	100 PCS	100 BAGS	50*30*44CM
Recyclable Tile Spacers 2.0mm	100 PCS	100 BAGS	50*30*44CM
Recyclable Tile Spacers 2.5mm	100 PCS	100 BAGS	50*30*46CM
Recyclable Tile Spacers 3.0mm	100 PCS	100 BAGS	50*30*46CM
Recyclable Tile Spacers 4.0mm	100 PCS	100 BAGS	50*30*48CM
Recyclable Tile Spacers 5.0mm	100 PCS	100 BAGS	50*30*48CM

8119-1

Wedge-type Tile Spacers



Size	PCS	BAGS	Dimensions
Wedge-type Tile Spacers 1-5mm	200 PCS	100 BAGS	45*40*35CM

8119-F5

Recyclable Tile Spacers



Size	PCS	BAGS	Dimensions
Recyclable Tile Spacers 1.0mm;1.5mm;2mm;2.5mm;3mm	100 PCS	100 BAGS	57*40*26CM

8119-1U

U-Shape Tile Spacers

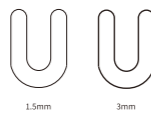

Size	PCS	BAGS	Dimensions
U-Shape Tile Spacers 1.5mm	100 PCS	100 BAGS	57*40*26CM
U-Shape Tile Spacers 3.0mm	100 PCS	100 BAGS	57*40*30CM

SQUARE FORMATS

cm	10 x 10	15 x 15	20 x 20	30 x 30	33 x 33	40 x 40	45 x 45	50 x 50	60 x 60	75 x 75	80 x 80	90 x 90
x m²	100	49	25	16	13	9	9	4	4	2	2	2
x m²	200	91	50	25	21	15	13	8	6	4	4	4

RECTANGULAR FORMATS

cm	15 x 60	15 x 90	15 x 120	20 x 40	20 x 60	20 x 80	20 x 100	25 x 100	30 x 60	30 x 90	30 x 120	40 x 80	40 x 120	45 x 90
x m²	16	10	8	18	12	9	7	6	8	5	4	4	3	3
x m²	26	17	13	29	19	14	12	9	16	9	6	7	5	6

LARGE SPECIAL FORMATS

cm	100 x 150	100 x 300	120 x 120	120 x 360	150 x 150	150 x 300
x m²	2	2	2	2	2	2
x m²	4	4	4	4	4	4



Tile Leveling System

8119-1P Tile Leveling Wedges

- High Quality PP Material.



Tile Leveling Wedges	100 PCS	20 BAGS	54*38*26CM
----------------------	---------	---------	------------



8119-2P Tile Leveling Clips

- High Quality PP Material.



Tile Leveling Clips 1.0mm	100 PCS	40 BAGS	52*40*40CM
Tile Leveling Clips 1.5mm	100 PCS	40 BAGS	52*40*40CM
Tile Leveling Clips 2.0mm	100 PCS	40 BAGS	52*40*40CM
Tile Leveling Clips 2.5mm	100 PCS	40 BAGS	52*40*40CM
Tile Leveling Clips 3.0mm	100 PCS	40 BAGS	52*40*40CM

8119-8PLIER Tile Leveling Plier

- Sturdy, steel construction with adjustable tension.
- Improve speed of tile laying.



Tile Leveling Plier	1 PC	50 PCS	42*42*50CM
---------------------	------	--------	------------

		SQUARE FORMATS									
	cm	30 x 30	40 x 40	45x45	50x50	60x60	75x75	80x80	90x90	100x100	120x120
	x m ²	40	23	18	14	10	10	8	7	5	4

		RECTANGULAR FORMATS													
	cm	15 x 60	15 x 89	15 x 120	23 x 40	23 x 60	23 x 75	23 x 100	30 x 100	30 x 60	30 x 90	30 x 120	40 x 80	40 x 120	45 x 90
	x m ²	30	27	20	30	20	21	16	15	20	17	13	14	9	11

		EXTRA-LARGE FORMATS					
	cm	100 x 150	100x300	120x120	120x360	150x150	150x300
	x m ²	4	3	4	2	3	2

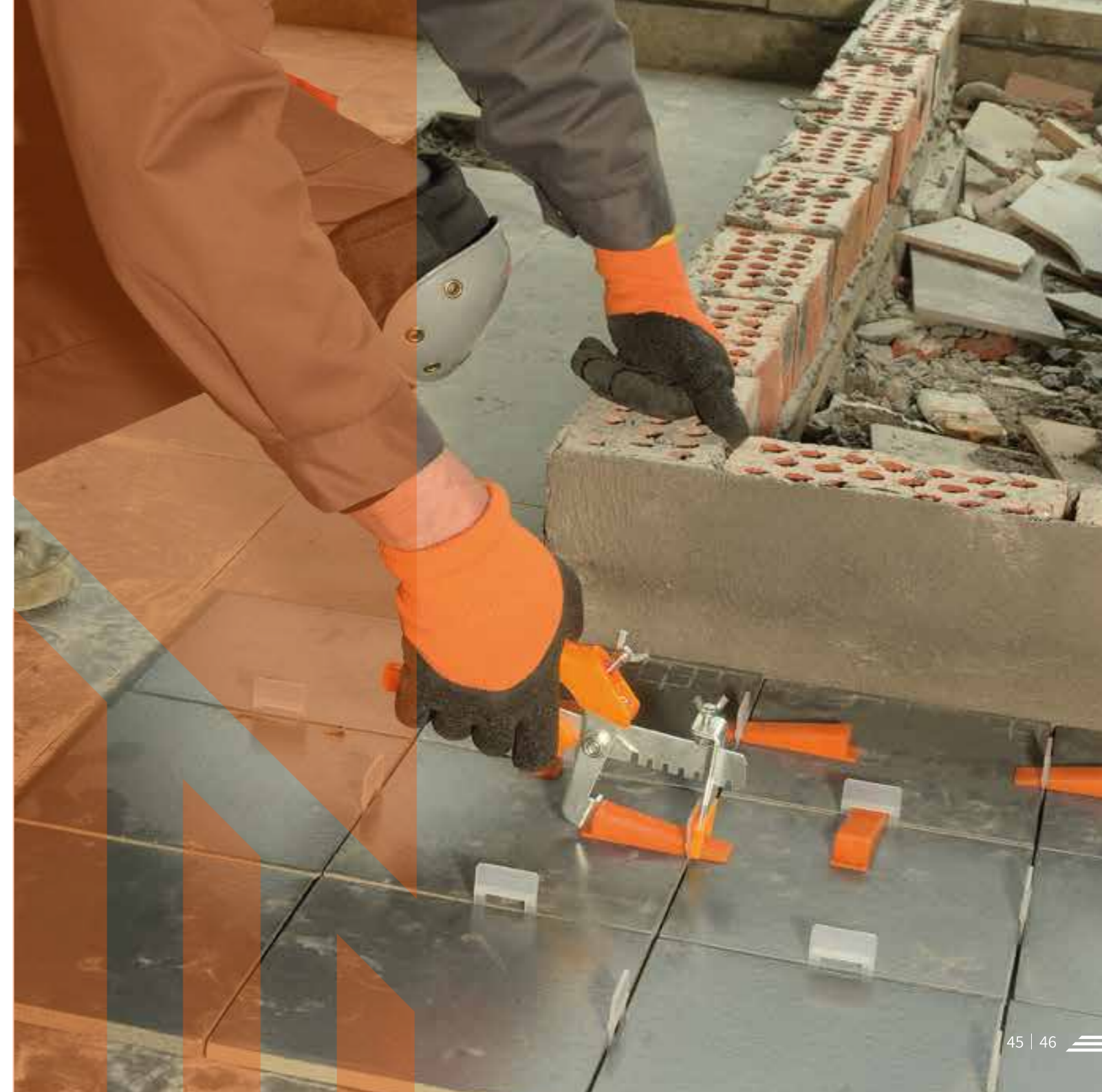

Tile Leveling System

NEW

8119-8R Recyclable Tile Leveling System

- Wear-resistant and reusable.
- Suitable for 3mm to 18mm thickness of the tile.
- Made of high-quality PP plastic.



Recyclable Tile Leveling System 50 PCS 20 BAGS 52*46*33CM

8119-8R(SET) Recyclable Tile Leveling System Set

- Wear-resistant and reusable.
- Suitable for 3mm to 18mm thickness of the tile.
- Made of high-quality PP plastic.



Recyclable Tile Leveling System Set 200 PCS 12 BOXES 42*40*30CM



SQUARE FORMATS										
cm	30 x 30	40 x 40	45x45	50x50	60x60	75x75	80x80	90x90	100x100	120x120
x m²	40	23	18	14	10	10	8	7	5	4

RECTANGULAR FORMATS														
cm	15 x 60	15 x 89	15 x 120	23 x 40	23 x 60	23 x 75	23 x 100	30 x 100	30 x 60	30 x 90	30 x 120	40 x 80	40 x 120	45 x 90
x m²	30	27	20	30	20	21	16	15	20	17	13	14	9	11

EXTRA-LARGE FORMATS						
cm	100 x 150	100x300	120x120	120x360	150x150	150x300
x m²	4	3	4	2	3	2

Tile Leveling System

8119-T1 Tile Leveling Screws

- The base of the screw ensures continuous tension between the screws and the caps.



Tile Leveling Screws 1.0mm 100 PCS 20 BAGS 54*44*42CM
 Tile Leveling Screws 1.5mm 100 PCS 20 BAGS 54*44*42CM
 Tile Leveling Screws 2.0mm 100 PCS 20 BAGS 54*44*42CM
 Tile Leveling Screws 2.5mm 100 PCS 20 BAGS 54*44*42CM
 Tile Leveling Screws 3.0mm 100 PCS 20 BAGS 54*44*42CM

8119-T2 Tile Leveling Caps

- Prevents uneven tiles when laying floors, especially large format tiles.



Tile Leveling Caps 50 PCS 20 BAGS 54*44*45CM



SQUARE FORMATS										
cm	30 x 30	40 x 40	45x45	50x50	60x60	75x75	80x80	90x90	100x100	120x120
x m²	40	23	18	14	10	10	8	7	5	4

RECTANGULAR FORMATS														
cm	15 x 60	15 x 89	15 x 120	23 x 40	23 x 60	23 x 75	23 x 100	30 x 100	30 x 60	30 x 90	30 x 120	40 x 80	40 x 120	45 x 90
x m²	30	27	20	30	20	21	16	15	20	17	13	14	9	11

EXTRA-LARGE FORMATS						
cm	100 x 150	100x300	120x120	120x360	150x150	150x300
x m²	4	3	4	2	3	2

GROUTING & CLEANING TOOLS

TILER Grouting & Cleaning Tools are designed to facilitate the grouting, caulking, and cleaning processes after tile installation. These tools are essential for achieving professional results, ensuring aesthetic appeal, and maintaining the cleanliness of your tiles.



8203E-7-U



8203E-7



8203E-7-V









8203F-4-U

- Smooth bottom surface, strong rigidity, and excellent elasticity for optimal performance.
- Easy application and uniform coverage for a professional finish.
- Rust-resistant and durable for long-lasting use.

- Durable stainless steel blade. Lightweight design.
- Square notched trowels for precise mortar application.
- Ergonomic handle, strong connection.

Trowel

NAME	ART.	Tooth		
Carbon steel Square Tooth Notched Trowel 10mm	8203E-7-U		a=10mm	6 36
Carbon steel Toothless Trowel	8203E-7			6 36
Carbon steel Sharp Tooth Notched Trowel	8203E-7-V		a=15mm,b=24mm	6 36
Stainless Steel Square Tooth Notched Trowel 6mm	8203F-4-U6		a=6mm	6 36
Stainless Steel Square Tooth Notched Trowel 8mm	8203F-4-U8		a=8mm	6 36
Stainless Steel Square Tooth Notched Trowel 10mm	8203F-4-U10		a=7.3mm,b=20mm,c=12mm	6 36



8203I-3-U Grout Float

- Design for smoothly spreading grout.
- Double color soft handle.

MODEL		
8203I-3-U	/	24PCS



8203N Grout Spreader 180mm Grout Spreader 300mm

- Design for easy and efficient grout application.
- Rubber thickness : 5mm.

MODEL		
8203N	10PCS	100/80PCS



8139-AB Sealant Remover Kit

- 3 in 1 silicone caulking tool.
- Perfectly handles various corner issues.

MODEL		
8139-AB	/	100PCS



8137-JT Sealant Remover Kit

- 9 different finishing profiles.
- Even in hard-to-reach places.

MODEL		
8137-JT	/	100PCS



8132 Tile Grout Saw

- TPR handle.
- Optional 1 or 2 blades.
- Diamond blades support high abrasion resistance.
- Use for removing grout.

MODEL		
8132	12PCS	60PCS



8131 Tile Grout Saw

- Carbide blade high abrasion resistance.
- Use for removing grout.

MODEL		
8131	12PCS	60PCS



8151-12L Cleaning Bucket Kit

- 12L bucket with wheels x1.
- Drying Rollers x1.
- Grate x1.
- Washing pad x2.

MODEL		
8151-12L	/	2PCS



8151-24L Cleaning Bucket Kit

- 24L bucket with wheels x1.
- Drying Rollers x1.
- Grate x1.
- Washing pad x2.

MODEL		
8151-24L	/	2PCS



8127-4 Cellulose Sponge

- Size : 165x110x50mm.
- 100% Cellulose.
- Ideal for all types of cleaning and decorating.

MODEL		
8127-4	/	50PCS



8127 Grout Sponge

- Size: 200x120x50mm.
- Ideal for removing excess grout.
- Clean the tile surface.

MODEL		
8127	/	50PCS



8127-3 Epoxy Grout Polishing Kit

- Kit comes with 3 different textured pads.
- Fine White Pad,Medium Red Pad,Coarse Black Pad.

MODEL		
8127-3	/	24PCS



8123H Squeegee 350mm Squeegee 450mm Squeegee 550mm Squeegee 600mm Squeegee 750mm

- Ideal for cleaning the tile surface.

MODEL		
8123H-350	/	72PCS
8123H-450	/	60PCS
8123H-550	/	48PCS
8123H-600	/	36PCS
8123H-750	/	30PCS

OTHER TILING TOOLS

TILER is committed to providing installers with a comprehensive tiling solution. Our range of tools covers all the necessary equipment for every step of the tiling process, from preparation, installation, and trimming to cleaning.

DIAMOND HOLE SAWS FOR DRILLS

It's made of high-strength carbon steel and premium diamond abrasive particles with a smooth nickel-plated surface to enhance its durability and service life.

It's ideally suited for drilling operations through ceramics, vitrified tiles, marble, granite, and other materials.



8123H

Size	Length of Shank	Overall Length	Shank Diameter	Opening Depth
4MM	30MM	65MM	7.1MM	30MM
5MM	30MM	65MM	7.1MM	30MM
6MM	30MM	65MM	5.1MM	30MM
6.5MM	30MM	65MM	5.5MM	30MM
8MM	30MM	65MM	7.1MM	30MM
10MM	35MM	65MM	7.8MM	30MM
12MM	35MM	65MM	7.8MM	30MM
14MM	35MM	65MM	7.8MM	30MM
16MM	35MM	65MM	7.8MM	30MM
18MM	35MM	65MM	7.8MM	30MM
20MM	35MM	65MM	9.5MM	30MM
22MM	35MM	65MM	9.5MM	30MM
25MM	35MM	65MM	9.5MM	30MM
28MM	35MM	65MM	9.5MM	30MM
30MM	35MM	65MM	9.5MM	30MM
32MM	35MM	65MM	9.5MM	30MM
35MM	35MM	65MM	9.5MM	30MM
38MM	35MM	65MM	9.5MM	30MM
40MM	35MM	65MM	9.5MM	30MM
42MM	35MM	65MM	9.5MM	30MM
45MM	35MM	65MM	9.5MM	30MM
50MM	35MM	65MM	9.5MM	30MM
53MM	35MM	65MM	9.5MM	30MM
55MM	35MM	65MM	9.5MM	30MM
60MM	35MM	65MM	9.5MM	30MM
65MM	35MM	65MM	9.5MM	30MM
68MM	35MM	65MM	9.5MM	30MM
70MM	35MM	65MM	9.5MM	30MM
75MM	35MM	65MM	9.5MM	30MM
80MM	35MM	65MM	9.5MM	30MM
85MM	35MM	65MM	9.5MM	30MM
90MM	35MM	65MM	9.5MM	30MM
95MM	35MM	65MM	9.5MM	30MM
100MM	35MM	65MM	9.5MM	30MM
105MM	35MM	65MM	9.5MM	30MM
110MM	35MM	65MM	9.5MM	30MM
115MM	35MM	65MM	9.5MM	30MM
120MM	35MM	65MM	9.5MM	30MM



8123J

Multi-function Hole Saw Locator.
*For: φ20-83MM



8123K

Mini Hole Saw Locator.
*For: φ4,6,8,10,12MM



8112A

ADJUSTABLE CIRCLE TILE BORER

- With tungsten carbide tips.
- Cutting capacity: 23-94mm.
- Chrome or zinc plated finish.

MODEL	Icon	Icon
8112A	5PCS	100PCS



8112D

TILE DRILL BITS 4MM
TILE DRILL BITS 5MM
TILE DRILL BITS 6MM
TILE DRILL BITS 8MM
TILE DRILL BITS 10MM
TILE DRILL BITS 12MM

- Tungsten carbide tipped.
- For drilling holes in ceramic tiles.

MODEL	Icon	Icon
8112D	/	250PCS



8119-9N Tile Height Adjuster

- Suitable for Tile Lifting.
- Advantages : Fine-Tunable.

MODEL		
8119-9N	/	200PCS



8119-9L Tile Height Adjuster

- Material : Steel.
- Adjustment Range : 1-10cm.
- Load-Bearing : 100KG.
- Freely Adjustable, Easy to Operate.

MODEL		
8119-9L	12PCS	60PCS



8403 Hand Rasp

- Strongly-molded ABS plastic body.
- Replaceable blade 140x40mm.
- Thumb screw for easy replacement.
- Perfect for smoothing uneven surfaces .

MODEL		
8403	10PCS	60PCS



8407 Hand Rasp

- Zinc-alloy body.
- Replaceable blade 140x40mm.
- Perfect for smoothing uneven surfaces.

MODEL		
8407	10PCS	60PCS



8404 Hand Rasp

- Strongly-molded ABS plastic handle.
- Replacement blade 250x40mm.
- Thumb screw for easy replacement.
- Perfect for smoothing uneven surfaces.

MODEL		
8404	10PCS	60PCS



8405 Hand Rasp

- Zinc-alloy body.
- Strongly-molded ABS plastic handle.
- Replacement blade 250x40mm.
- Perfect for smoothing uneven surfaces.

MODEL		
8405	15PCS	60PCS



8129B-1 Knee Pads

- Hard shell exterior.
- Padded interior.
- Strong Double Straps .
- Idea for work protection.

MODEL		
8129B-1	/	24PAIRS



8129B Heavy Duty Knee Pads

- Thick Gel Cushion.
- Padded interior.
- Strong wide Straps.
- Idea for work protection.

MODEL		
8129B	/	20PAIRS



8126C-3 Tile Glass Mosaic Nipper

- For cutting and trimming ceramic tiles of any required shapes up to 10mm thick.
- Double color TPR handle grip.

MODEL		
8126C-3	4PCS	40PCS



8126A-N Tile Glass Mosaic Nipper

- For cutting and trimming ceramic tiles of any required shapes up to 12mm thick.
- Double color TPR handle grip.

MODEL		
8126A-N	4PCS	40PCS



8126A-O Tile Glass Mosaic Nipper

- With 2 tungsten carbide cutting wheels : Ø22xØ6x2.
- Double color TPR handle grip.

MODEL		
8126A-O	4PCS	40PCS



8126F Tile Glass Mosaic Nipper

- With a tungsten carbide cutting wheel: Ø15xØ6x1.5.
- Double color TPR handle grip.

MODEL		
8107F	4PCS	40PCS



8119-6B Spirit Level 60cm Spirit Level 80cm Spirit Level 100cm

- Heavy duty aluminum alloy frames.
- Horizontal, vertical and 45° bubble level.
- Strong magnetic.

MODEL		
8119-6B	/	30PCS



8121 5m Tape Measure

- ABS Shockproof Case, Orange Coated Rubber.
- Automatic locking, press to retract.

MODEL		
8121	12PCS	120PCS



8122 Contour Gauge 6" Coutour Gauge 10"

- Made of premium ABS plastic, very durable and sturdy.
- Perfect for use in wood cataloging moulding.

MODEL		
8122	/	50PCS



8224 Grout Spreader

- Ideal for cleaning tile surface.

MODEL		
8224	/	100PCS



8124G

Rubber Mallet 8oz
Rubber Mallet 12oz
Rubber Mallet 16oz
Rubber Mallet 24oz
Rubber Mallet 32oz

- Rubber head.
- TPR handle.
- No damage to the tiles.

MODEL		
8124G	/	12PCS



8124A

Rubber Mallet 8oz
Rubber Mallet 12oz
Rubber Mallet 16oz
Rubber Mallet 24oz
Rubber Mallet 32oz

- Rubber head.
- Wooden handle.
- No damage to the tiles.

MODEL		
8124A-8OZ	/	72PCS
8124A-12OZ	/	60PCS
8124A-16OZ	/	48PCS
8124A-24OZ	/	36PCS
8124A-32OZ	/	30PCS

8203I-9

Heavy Duty Tile Beater



- Size : 355 x 146mm.
- Remove air from under the tile.
- Heavy duty rubber pad.



MODEL		
8203I-9	/	12PCS

8118-2B

Diamond Hand Pad Grain # 60
Diamond Hand Pad Grain # 100
Diamond Hand Pad Grain # 200
Diamond Hand Pad Grain # 400

- Diamond + High Hardness High Elasticity Sponge.
- Works great for granite, engineered stone, glass, concrete, marble etc.

MODEL		
8118-2B	/	50PCS

DE-D105A

Diamond Disc 105



- Professional level.
- Size : Ø105xØ20x1.2mm.
- For both wet and dry cutting.
- Made with premium diamond particles.
- Compatible with most electric tile cutters.
- For stone, marble, granite, porcelain and ceramics.

MODEL		
DE-D105A	20PCS	200PCS



DE-D105B

Diamond Disc 105

- Industrial level.
- Size : Ø105xØ20x1.1mm.
- For both wet and dry cutting.
- Made with premium diamond particles.
- Compatible with most electric tile cutters.
- For stone, marble, granite, porcelain and ceramics.

MODEL		
DE-D105B	20PCS	200PCS

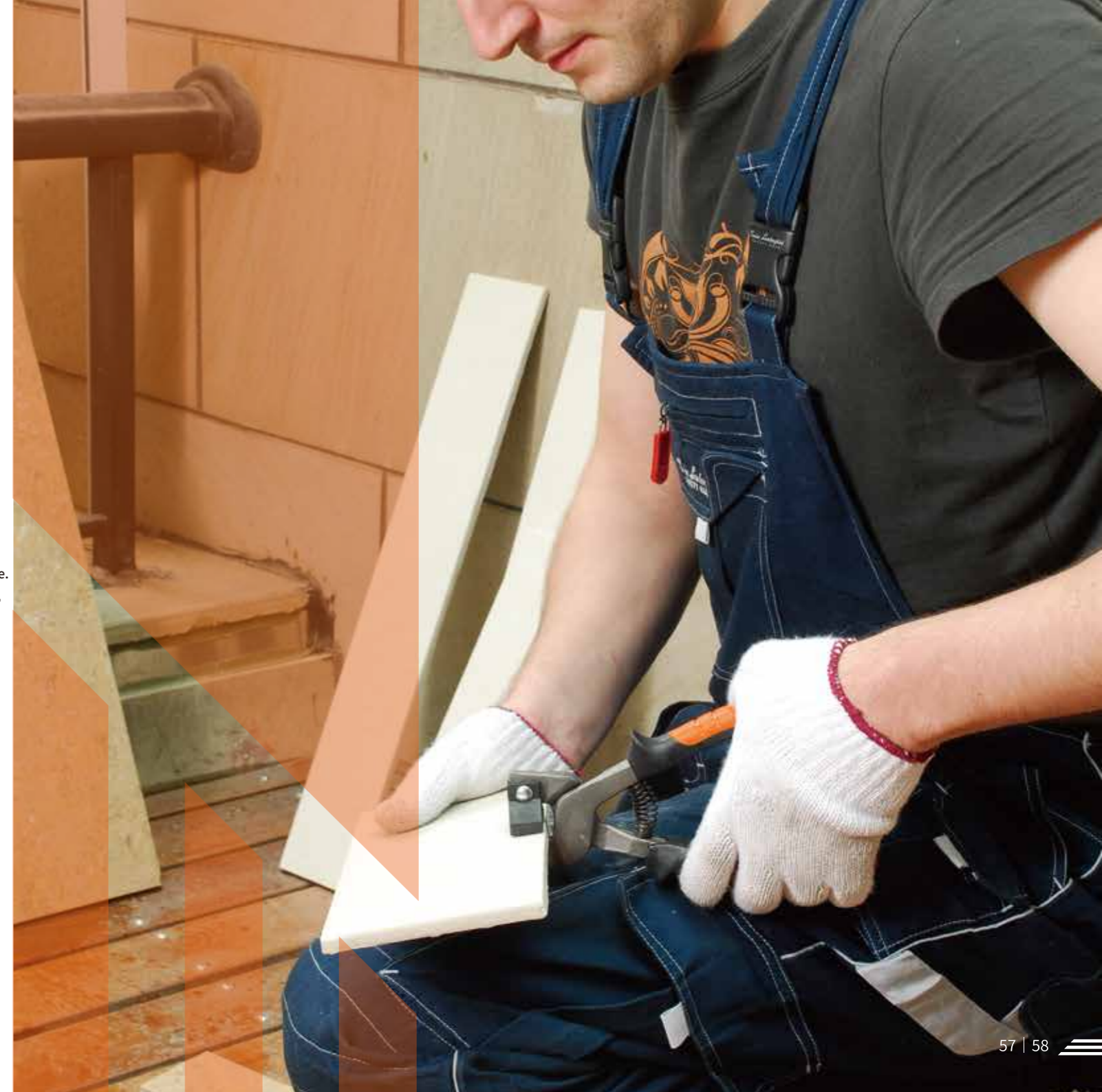



8008 TILER shelf

- Made of Iron.
- Professional shelves with exquisite appearance, sturdy and durable.
- High space utilization.
- Designed specifically for TILER tools to improve sales efficiency.
- Become an agent of the TILER brand and have the opportunity to get shelves for free.
- Customizable size according to site requirements.

MODEL		
8008	/	1 SET in 2 CTN.



DISTRIBUTION

We Warmly Welcome Global Business Partners to Join TILER Distributors Family and Lead the Tiling Tools Industry Together!

Technical

Trusted

Tenacious

Thrive

Talented

Trusted

Technical

Tenacious

Thrive

Talented



Instagram



Facebook



YouTube



www.tilertool.com



info@tilertool.com



+86-571-88637866



Hangzhou John Hardware Tools CO.,Ltd



Building 1, No.283 Renkang Road, Renhe Street,
Yuhang District, Hangzhou, Zhejiang, China 311107